

FLUKE®

Calibration

6020 Series

Calibration Baths

User's Guide

PN 3720771

April 2013

© 2013 Fluke Corporation. All rights reserved. Specifications are subject to change without notice.

All product names are trademarks of their respective companies.

LIMITED WARRANTY AND LIMITATION OF LIABILITY

Each Fluke product is warranted to be free from defects in material and workmanship under normal use and service. The warranty period is one year and begins on the date of shipment. Parts, product repairs, and services are warranted for 90 days. This warranty extends only to the original buyer or end-user customer of a Fluke authorized reseller, and does not apply to fuses, disposable batteries, or to any product which, in Fluke's opinion, has been misused, altered, neglected, contaminated, or damaged by accident or abnormal conditions of operation or handling. Fluke warrants that software will operate substantially in accordance with its functional specifications for 90 days and that it has been properly recorded on non-defective media. Fluke does not warrant that software will be error free or operate without interruption.

Fluke authorized resellers shall extend this warranty on new and unused products to end-user customers only but have no authority to extend a greater or different warranty on behalf of Fluke. Warranty support is available only if product is purchased through a Fluke authorized sales outlet or Buyer has paid the applicable international price. Fluke reserves the right to invoice Buyer for importation costs of repair/replacement parts when product purchased in one country is submitted for repair in another country.

Fluke's warranty obligation is limited, at Fluke's option, to refund of the purchase price, free of charge repair, or replacement of a defective product which is returned to a Fluke authorized service center within the warranty period.

To obtain warranty service, contact your nearest Fluke authorized service center to obtain return authorization information, then send the product to that service center, with a description of the difficulty, postage and insurance prepaid (FOB Destination). Fluke assumes no risk for damage in transit. Following warranty repair, the product will be returned to Buyer, transportation prepaid (FOB Destination). If Fluke determines that failure was caused by neglect, misuse, contamination, alteration, accident, or abnormal condition of operation or handling, including overvoltage failures caused by use outside the product's specified rating, or normal wear and tear of mechanical components, Fluke will provide an estimate of repair costs and obtain authorization before commencing the work. Following repair, the product will be returned to the Buyer transportation prepaid and the Buyer will be billed for the repair and return transportation charges (FOB Shipping Point).

THIS WARRANTY IS BUYER'S SOLE AND EXCLUSIVE REMEDY AND IS IN LIEU OF ALL OTHER WARRANTIES, EXPRESS OR IMPLIED, INCLUDING BUT NOT LIMITED TO ANY IMPLIED WARRANTY OF MERCHANTABILITY OR FITNESS FOR A PARTICULAR PURPOSE. FLUKE SHALL NOT BE LIABLE FOR ANY SPECIAL, INDIRECT, INCIDENTAL, OR CONSEQUENTIAL DAMAGES OR LOSSES, INCLUDING LOSS OF DATA, ARISING FROM ANY CAUSE OR THEORY.

Since some countries or states do not allow limitation of the term of an implied warranty, or exclusion or limitation of incidental or consequential damages, the limitations and exclusions of this warranty may not apply to every buyer. If any provision of this Warranty is held invalid or unenforceable by a court or other decision-maker of competent jurisdiction, such holding will not affect the validity or enforceability of any other provision.

Fluke Corporation
P.O. Box 9090
Everett, WA 98206-9090
U.S.A.

Fluke Europe B.V.
P.O. Box 1186
5602 BD Eindhoven
The Netherlands

Table of Contents

1	Before You Start	1
1.1	Symbols Used	1
1.2	Safety Information	2
1.2.1	Warnings	2
1.2.2	Cautions	4
1.3	Authorized Service Centers.	6
2	Introduction	9
3	Specifications and Environmental Conditions	11
3.1	Specifications	11
3.2	Environmental Conditions.	12
4	Quick Start	13
4.1	Unpacking	13
4.2	Set Up	13
4.3	Power	14
4.4	Setting the Temperature	14
5	Installation	17
5.1	Bath Environment	17
5.2	“Dry-out” Period	18
5.3	Bath Preparation and Filling	18
5.4	Probe	18
5.5	Power	19
5.6	Tipping Prevention Brackets Installation (6024 with model 2072 cart only)	19
5.6.1	Installation on a Concrete Floor	19
5.6.2	Installation of the Bath	19
6	Bath Use	21
6.1	General	21
6.2	Comparison Calibration	21
6.3	Calibration of Multiple Probes	22
7	Parts and Controls	23

7.1	Front Panel	23
7.2	Bath Tank and Lid	25
7.3	Back Panel	26
8	General Operation	29
8.1	Bath Fluid	29
8.1.1	Temperature Range	29
8.1.2	Viscosity	29
8.1.3	Specific Heat	29
8.1.4	Thermal Conductivity	30
8.1.5	Thermal Expansion	30
8.1.6	Electrical Resistivity	30
8.1.7	Fluid Lifetime	30
8.1.8	Safety	30
8.1.9	Cost	31
8.1.10	Commonly Used Fluids	31
8.1.10.1	Water	31
8.1.10.2	Ethylene Glycol	31
8.1.10.3	Mineral Oil	31
8.1.10.4	Silicone Oil	32
8.1.11	Fluid Characteristics Charts	32
8.1.11.1	Limitations and Disclaimer	32
8.1.11.2	About the Graph	32
8.2	Stirring	35
8.3	Power	35
8.4	Heater	35
8.5	Cooling	36
8.6	Temperature Controller	36
9	Controller Operation	39
9.1	Bath temperature	39
9.2	Reset Cutout	39
9.3	Temperature Set-point	41
9.3.1	Programmable Set-points	41
9.3.2	Set-point Value	42
9.3.3	Set-point Vernier	42
9.4	Temperature Scale Units	43
9.5	Secondary Menu	43
9.6	Heater Power	44
9.7	Proportional Band	44
9.8	Cutout	47
9.9	Controller Configuration	48
9.10	Probe Parameters	48
9.10.1	R_0	48

9.10.2	ALPHA	48
9.11	Operating Parameters	48
9.11.1	Cutout Reset Mode	49
9.12	Serial Interface Parameters	49
9.12.1	Baud Rate	49
9.12.2	Sample Period.	50
9.12.3	Duplex Mode	50
9.12.4	Linefeed.	51
9.13	IEEE-488 Parameters	51
9.13.1	IEEE-488 Address	51
9.14	Calibration Parameters	52
9.14.1	CTO	52
9.14.2	CO and CG	52
9.14.3	H and L	52
10	Digital Communication Interface	53
10.1	Serial Communications	53
10.1.1	Wiring	54
10.1.2	Setup	54
10.1.2.1	Baud Rate	54
10.1.2.2	Sample Period.	54
10.1.2.3	Duplex Mode	55
10.1.2.4	Linefeed.	55
10.1.3	Serial Operation.	55
10.2	IEEE-488 Communication (optional)	55
10.2.1	Setup and Address Selection	55
10.2.2	IEEE-488 Operation	56
10.3	Interface Commands	56
10.4	Power Control Functions	57
11	Calibration Procedure	61
11.1	Calibration Points	61
11.2	Measuring the Set-point Error.	61
11.3	Computing R0 and ALPHA	61
11.4	Calibration Example.	62
12	Maintenance	65
12.1	Draining the Bath	66
13	Troubleshooting.	69
13.1	Troubleshooting	69
14	Appendix – Model 6021	73
14.1	Installation.	73

14.2 Chiller Parts and Controls 74
14.3 Chiller Controller Operation 75

Figures

Figure 1	6020 Series of Calibration Baths	9
Figure 2	Tipping Prevention Bracket Installation	20
Figure 3	Front Panel Features	23
Figure 4	Typical 6020 Series Calibration Bath	24
Figure 5	Back Panel	26
Figure 6	Chart of Various Bath Fluids	34
Figure 7	Controller Operation Flowchart	40
Figure 8	Bath Temperature Fluctuation at Various Proportional Band Settings . .	45
Figure 9	Serial Communications Cable Wiring	54
Figure 10	Calibration Example	63
Figure 11	6021 Back panel	75

Tables













Table 1	International Electrical Symbols	1
Table 2	Table of Various Fluids and Their Properties	33
Table 3	Proportional Band — Fluid Table	46
Table 4	Power Control Functions.	57
Table 5	Interface Command Summary	58
Table 5	Interface Command Summary continued	59
Table 6	Auxiliary Chiller Control Functions	75



1 Before You Start

1.1 Symbols Used

Table 1 lists the International Electrical Symbols. Some or all of these symbols may be used on the instrument or in this manual.

Table 1 International Electrical Symbols

Symbol	Description
	AC (Alternating Current)
	AC-DC
	Battery
	CE Complies with European Union Directives
	DC
	Double Insulated
	Electric Shock
	Fuse
	PE Ground
	Hot Surface (Burn Hazard)
	Read the User's Manual (Important Information)
	Off
	On

Symbol	Description
	Canadian Standards Association
CAT II	OVERVOLTAGE (Installation) CATEGORY II, Pollution Degree 2 per IEC1010-1 refers to the level of Impulse Withstand Voltage protection provided. Equipment of OVERVOLTAGE CATEGORY II is energy-consuming equipment to be supplied from the fixed installation. Examples include household, office, and laboratory appliances.
	C-TIC Australian EMC Mark
	The European Waste Electrical and Electronic Equipment (WEEE) Directive (2002/96/EC) mark.

1.2 Safety Information

Use this instrument only as specified in this manual. Otherwise, the protection provided by the instrument may be impaired.

The following definitions apply to the terms “Warning” and “Caution”.

- “Warning” identifies conditions and actions that may pose hazards to the user.
- “Caution” identifies conditions and actions that may damage the instrument being used.

1.2.1 Warnings

To avoid personal injury, follow these guidelines.

GENERAL

- Appropriate personal safety protection should be worn by the operator at all times while using the bath.
- **DO NOT** use the instrument for any application other than calibration work. The instrument was designed for temperature calibration. Any other use of the unit may cause unknown hazards to the user.
- **DO NOT** use the unit in environments other than those listed in the user’s guide.
- **DO NOT** overfill the bath. Overflowing extremely hot fluid may be harmful to the operator. See Section 5.3, Bath Preparation and Filling, for specific instructions.
- Follow all safety guidelines listed in the user’s manual.
- Calibration Equipment should only be used by Trained Personnel.
- If this equipment is used in a manner not specified by the manufacturer, the protection provided by the equipment may be impaired.

- Before initial use, or after transport, or after storage in humid or semi-humid environments, or anytime the instrument has not been energized for more than 10 days, the instrument needs to be energized for a “dry-out” period of 2 hours before it can be assumed to meet all of the safety requirements of the IEC 1010-1. If the product is wet or has been in a wet environment, take necessary measures to remove moisture prior to applying power such as storage in a low humidity temperature chamber operating at 50°C for 4 hours or more.
- **DO NOT** operate high temperature baths near flammable materials. Extreme temperatures could ignite the flammable material.
- Overhead clearance is required. Do not place the instrument under a cabinet or other structure. Always leave enough clearance to allow for safe and easy insertion and removal of probes.
- The instrument is intended for indoor use only.
- Ensure that you check the appropriate OSHA and local fire code regulations for proper equipment required to suppress a fire for the fluid utilized in the bath.

BURN HAZARD

- High temperatures may be present in this equipment. Fires and severe burns may result if personnel fail to observe safety precautions.
- Ensure the bath **DOES NOT** contain any water and has been completely dried prior to filling with fluid. Any trapped water can cause a steam explosion resulting in personal injury. If the bath has recently been filled with water, ensure the inside of the drain tube is dry prior to filling the bath with fluid.
- When immersing any object in the bath, ensure that you are not introducing anything into the bath that will react with the bath fluid. Ensure that probes are **DRY** and free of contaminants. Read the MSDS (Material Safety Data Sheet) for the bath fluid used.
- The bath is provided with an access cover. The access cover can be modified to allow the probes being calibrated to be inserted through the access cover. The bath should be operated with the access cover on at all times. Operating the bath without the access cover reduces stability, increases out gassing of fluids, and increases the possibility of personal injury or fire hazard.
- When removing probes from the bath **DO NOT** wipe probes down with a paper towel. If the bath setpoint is high, the paper towel can ignite in your hand. Provide a safe surface and situation for the probes to cool prior to cleaning them.
- The bath generates extreme temperatures. Precautions must be taken to prevent personal injury or damage to objects. Probes may be extremely hot when removed from the bath. Cautiously handle probes to prevent personal injury. Carefully place probes on a heat resistant surface or rack until they are at room temperature.

- Be extremely careful when filling the bath and bringing it up to temperature. Most fluids expand with temperature. It is easy to add fluid, but extremely dangerous to remove hot fluid when the bath is over filled. **DO NOT** fill the bath above the indicated fill line when the stirring is on. It will overflow.

ELECTRICAL HAZARD

- These guidelines must be followed to ensure that the safety mechanisms in this instrument will operate properly. The power cord of the instrument is equipped with a three-pronged grounding plug for your protection against electrical shock hazards. It must be plugged directly into a properly grounded three-prong receptacle. The receptacle must be installed in accordance with local codes and ordinances. Consult a qualified electrician. **DO NOT** use an extension cord or adapter plug.
- **DO** use a ground fault interrupt device. This unit contains a liquid. A ground fault device is advised in case liquid is present in the electrical system and could cause an electrical shock.
- Always replace the power cord with an approved cord of the correct rating and type. If you have questions, contact an Authorized Service Center (see Section 1.3).
- High voltage is used in the operation of this equipment. Severe injury or death may result if personnel fail to observe the safety precautions. Before working inside the equipment, turn off the power and disconnect the power cord.
- Keep all combustible materials away from the bath. Operate the bath on a heatproof surface such as concrete. Provide a means of safety for containing any spill, which may occur.

BATH FLUIDS

- Fluids used in this unit may produce noxious or toxic fumes under certain circumstances. Consult the fluid manufacturer's MSDS (Material Safety Data Sheet). Proper ventilation and safety precautions must be observed.
- The unit is equipped with a soft cutout (user settable firmware) and a hard cutout (set at the factory). Check the flash point, boiling point, or other fluid characteristic applicable to the circumstances of the unit operation. Ensure that the soft cutout is adjusted to the fluid characteristics of the application. Failing to set the cutout to the limits of the bath fluid can result in fire hazards and personal injury.

1.2.2 Cautions

To avoid possible damage to the instrument, follow these guidelines.

- Always operate this instrument at room temperature between 41°F and 104°F (5°C to 40°C). Allow sufficient air circulation by leaving at least 6 inches (15 cm) of clearance around the instrument.

- **DO NOT** overfill the bath. Overflowing liquid may damage the electrical system. Be sure to allow for thermal expansion of the fluid as the bath temperature increases. See Section 5.3, Bath Preparation and Filling, for specific instructions.
- Read Section 6, Bath Use, before placing the unit into service.
- **DO NOT** change the values of the bath calibration constants from the factory set values. The correct setting of these parameters is important to the safety and proper operation of the unit.
- Only authorized personnel should perform the Factory Reset Sequence if no other action is successful in correcting a malfunction. You must have a copy of the most recent Report of Test to restore the test parameters.
- **DO NOT** operate this instrument in an excessively wet, oily, dusty, or dirty environment.
- The bath is a precision instrument. Although it has been designed for optimum durability and trouble free operation, it must be handled with care. Position the bath before the tank is filled with fluid.
- Most probes have handle temperature limits. Be sure that the probe handle temperature limit is not exceeded in the air above the instrument.
- The instrument and any thermometer probes used with it are sensitive instruments that can be easily damaged. Always handle these devices with care. Do not allow them to be dropped, struck, stressed, or overheated.
- **DO** ensure the fluid is cleaned from the probes prior to immersing the probe in the next bath. Clean your probe between each bath to avoid contamination between bath fluids.
- Under filling the bath may reduce the bath performance and may possibly damage the bath.
- When calibrating PRTs always follow correct calibration procedure and calibrate from high temperatures to low temperatures with the appropriate triple point of water checks. Never immerse a wet or cold PRT into a bath filled with hot fluid. Severe damage to the PRT may result as well as personal injury to the calibration technician.
- This bath is not designed to be portable. Therefore, moving the bath once it has been installed should be kept to a minimum. **NEVER MOVE A BATH THAT IS FULL OF “HOT” FLUID.** This action could be extremely dangerous and could result in personal injury to the person moving the bath. If the bath is going to be placed in an area where it may need to be moved frequently, Hart Scientific sells a special cart designed to accommodate the bath. However, even with a cart the bath should not be moved full of “hot” fluid. The fluid can splash causing injury or if the bath and cart tip, the “hot” fluid could cause damage to the surrounding area and personnel.
- If the bath must be moved, be sure to drain the fluid to prevent any injury. To safely move the bath, two people are required. One person should lift

the bath by the tower, while the second person lifts from underneath the bath tank.

- The control probe must be inserted through the lid into the bath fluid and plugged into the socket at the back of the bath. **DO NOT** operate the bath without the control probe properly inserted and attached. The bath will not operate correctly without the control probe. Injury to operating personnel and permanent damage to the bath could occur.

1.3 Authorized Service Centers

Please contact one of the following authorized Service Centers to coordinate service on your Hart product:

Fluke Corporation, Hart Scientific Division

799 E. Utah Valley Drive
American Fork, UT 84003-9775
USA

Phone: +1.801.763.1600
Telefax: +1.801.763.1010
E-mail: support@hartscientific.com

Fluke Nederland B.V.

Customer Support Services
Science Park Eindhoven 5108
5692 EC Son
NETHERLANDS

Phone: +31-402-675300
Telefax: +31-402-675321
E-mail: ServiceDesk@fluke.nl

Fluke Int'l Corporation

Service Center - Instrimpex
Room 2301 Sciteck Tower
22 Jianguomenwai Dajie
Chao Yang District
Beijing 100004, PRC
CHINA

Phone: +86-10-6-512-3436
Telefax: +86-10-6-512-3437
E-mail: xingye.han@fluke.com.cn

Fluke South East Asia Pte Ltd.

Fluke ASEAN Regional Office
Service Center
60 Alexandra Terrace #03-16
The Comtech (Lobby D)
118502
SINGAPORE

Phone: +65 6799-5588
Telefax: +65 6799-5588
E-mail: antng@singa.fluke.com

When contacting these Service Centers for support, please have the following information available:

- Model Number
- Serial Number
- Voltage
- Complete description of the problem

2 Introduction

The Hart Scientific 6020 series hot baths are constant temperature baths intended mainly for the application of temperature calibration. However, their high stability and the availability of factory modifications, such as a circulation pump, make these baths suitable for other uses as well.



Figure 1 6020 Series of Calibration Baths

3 Specifications and Environmental Conditions

3.1 Specifications

	6020	6021	6022	6024
Range	40°C to 300°C	40°C to 200°C	40°C to 300°C	40°C to 300°C
Stability	±0.001°C at 40°C (water) ±0.003°C at 100°C (oil) ±0.005°C at 300°C (oil)			
Uniformity	±0.002°C at 40°C (water) ±0.004°C at 100°C (oil) ±0.012°C at 300°C (oil)			
Temperature Setting	Digital display with push-button data entry			
Set-point Resolution	0.01°C; high-resolution mode, 0.00018°C			
Display Temperature Resolution	0.01°C			
Digital Setting Accuracy	±1°C			
Digital Setting Repeatability	±0.02°C			
Heaters	350 and 1050 watts	250 and 1250 watts	350 and 1050 watts	
Access Opening	5" x 10" (127 x 254 mm)	7.25" x 12" (184 x 305 mm)	5" x 10" (127 x 254 mm)	7.25" x 12.75" (184 x 324 mm)
Depth	12" (305 mm)	18.25" (464 mm)	18.25" (464 mm)	13.25" (337 mm)
Wetted Parts	304 Stainless Steel			
Power	115/230 VAC (±10%), 50/60 Hz, 1350 W	115/230 VAC (±10%), 50/60 Hz, 1518 W	115/230 VAC (±10%), 50/60 Hz, 1350 W	115/230 VAC (±10%), 50/60 Hz, 1350 W
Auxiliary Chiller Outlet Power (MAX)	NA	115 VAC (±10%), 10 A, 1150 W 230 VAC (±10%), 5 A, 1150 W	NA	NA
System Fuse	115 VAC: 15 A, 250 V, F 230 VAC: 8 A, 250 V, F	115 VAC: 20 A, 250 V, F 230 VAC: 10 A, 250 V, F	115 VAC: 15 A, 250 V, F 230 VAC: 8 A, 250 V, F	115 VAC: 15 A, 250 V, F 230 VAC: 8 A, 250 V, F
Heater Fuse	115 VAC: 12 A, 250 V, F 230 VAC: 6 A, 250 V, F	115 VAC: 15 A, 250 V, F 230 VAC: 8 A, 250 V, F	115 VAC: 12 A, 250 V, F 230 VAC: 6 A, 250 V, F	115 VAC: 12 A, 250 V, F 230 VAC: 6 A, 250 V, F
Volume	7.2 gallons (27 liters)	11.2 gallons (42 liters)		
Weight	70 lb. (32 kg)	80 lb. (36 kg)	80 lb. (36 kg)	80 lb. (36 kg)
Size	25.5" H x 16" W x 20" D (648 x 406 x 508 mm)	32" H x 16" W x 20" D (813 x 406 x 508 mm)	32" H x 16" W x 20" D (813 x 406 x 508 mm)	27.5" H x 19" W x 23" D (699 x 483 x 587 mm)
Automation Package	Interface- <i>it</i> software and RS-232 computer interface are available for setting bath temperature via remote computer. For IEEE-488, add the 2001-IEEE to the automation package.			

3.2 Environmental Conditions

These instruments have been designed for optimum durability and trouble-free operation, however, they must be handled with care. The instrument should not be operated in an excessively dusty or dirty environment. Maintenance and cleaning recommendations can be found in the Maintenance Section of this manual.

The instrument operates safely under the following conditions:

- ambient temperature range: 5 - 40°C (41 - 104°F)
- ambient relative humidity: maximum 80% for temperature < 31°C, decreasing linearly to 50% at 40°C
- pressure: 75kPa - 106kPa
- mains voltage within $\pm 10\%$ of nominal
- vibrations in the calibration environment should be minimized
- altitude less than 2,000 meters
- indoor use only

4 Quick Start



CAUTION: READ SECTION 6 ENTITLED BATH USE before placing the bath in service. Incorrect handling can damage the bath and void the warranty.

This section gives a brief summary of the steps required to set up and operate the bath. This should be used as a general overview and reference and not as a substitute for the remainder of the manual. Please read Sections 5 through 8 carefully before operating the bath.

4.1 Unpacking

Unpack the bath carefully and inspect it for any damage that may have occurred during shipment. If there is shipping damage, notify the carrier immediately.

Verify that all components are present:

- Bath
- Access Hole Cover
- Control Probe
- Manual
- Report of Test

If you are missing any item, please call an Authorized Service Center (see Section 1.3) or assistance.

4.2 Set Up

Set up of the bath requires careful unpacking and placement of the bath, filling the bath with fluid, installing the probe and connecting power. Consult Section 5 for detailed instructions for proper installation of the bath. Be sure to place the bath in a safe, clean and level location.

Fill the bath tank with an appropriate liquid. For operation at warm bath temperatures, clean distilled water works well. Carefully pour the fluid into the bath tank through the large rectangular access hole above the tank avoiding spilling any fluid. The fluid must not exceed a height of 1/2 inch below the bath lid.

The control probe **must be** inserted through the lid into the bath and plugged into the socket at the back of the bath. DO NOT operate the bath without the control probe properly installed.

4.3 Power

Plug the bath power cord into a mains outlet of the proper voltage, frequency, and current capability. See Section 3.1, Specifications. Set the “HEATER” switch on the front panel to position “LOW” and turn the bath on using the front panel “POWER” switch. The bath will turn on and begin to heat or cool to reach the previously programmed temperature set-point. The front panel LED display will indicate the actual bath temperature.

4.4 Setting the Temperature

In the following discussion and throughout this manual a solid box around the word SET, UP, EXIT or DOWN indicates the panel button while the dotted box indicates the display reading. Explanation of the button or display reading are to the right of each button or display value.

To view or set the bath temperature set-point proceed as follows. The front panel LED display normally shows the actual bath temperature.

 *Bath temperature display*

When “SET” is pressed the display will show the set-point memory that is currently being used and its value. Eight set-point memories are available.

 *Access set-point selection*

 *Set-point 1, 25.0°C currently used*

Press “SET” to select this memory and access the set-point value.

 *Access set-point value*

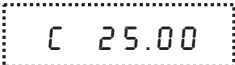
 *Current value of set-point 1, 25.00°C*

Press “UP” or “DOWN” to change the set-point value.

 *Increment display*

 *New set-point value*

Press “SET” to accept the new value and display the vernier value. The bath begins heating or cooling to the new set-point.

 *Store new set-point, access vernier*

 *Current vernier value*

Press “EXIT” and the bath temperature will be displayed again.



Return to the temperature display

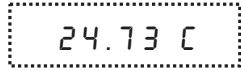

Bath temperature display

The bath will heat or cool until it reaches the new set-point temperature. Set the heater switch to position “HIGH” to allow the bath to more quickly reach a higher temperature. The “HIGH” setting may be necessary to reach higher temperatures and control at high temperatures.

When setting the set-point temperature be careful not to exceed the temperature limit of the bath fluid. The over-temperature cutout should be correctly set to prevent this from happening. See Section 9.8.

To obtain optimum control stability adjust the proportional band as discussed in Section 9.7.

5 Installation



CAUTION: READ SECTION 6 ENTITLED BATH USE before placing the bath in service. Incorrect handling can damage the bath and void the warranty.

This bath is not designed to be portable. Therefore, moving the bath once it has been installed should be kept to a minimum.

Never move a bath that is full of “hot” fluid. This action could be extremely dangerous and could result in personal injury to the person moving the bath.

If the bath is going to be placed in an area where it will need to be moved frequently, a special cart can be designed to accommodate the bath. Thus making the bath much more portable. Hart sells carts designed for these baths. However, even with a cart the bath should not be moved full of “hot” fluid. The fluid can splash causing injury or if the bath and cart tip, the “hot” fluid could cause damage to the surrounding area and personal injury to personnel.

If the bath must be moved, be sure to drain the fluid to prevent any injury. To safely move the bath, two people are required. One person should lift the bath by the tower, while the second person slides their hands underneath the bath tank and lifts the bath.

Refer to the Appendix specific to your bath model for additional installation instructions.

5.1 Bath Environment



CAUTION: DO NOT place under a cabinet or other structure. Allow for overhead clearance.

The bath is a precision instrument which should be located in an appropriate environment. The location should be free of drafts, extreme temperatures and temperature changes, dirt, etc. The surface where the bath is placed must be level.

Because the bath is designed for operation at high temperatures, keep all flammable and meltable materials away from the bath. Although the bath is well insulated, top surfaces do become hot. Beware of the danger of accidental fluid spills.

If used at high temperatures, a fume hood should be used to remove any vapors given off by hot bath fluid.

Allow for sufficient air circulation by leaving at least six inches of space between the bath and nearby objects.

5.2 “Dry-out” Period

Before initial use, after transport, and any time the instrument has not been energized for more than 10 days, the bath needs to be energized for a “dry-out” period of 1-2 hours before it can be assumed to meet all of the safety requirements of the IEC 1010-1.

5.3 Bath Preparation and Filling

Baths are not provided with fluid. Various fluids are available from Hart Scientific and other sources. Depending on the desired temperature range, any of the following fluids, as well as others, may be used in the bath:

- Water
- Ethylene Glycol/Water
- Mineral oil
- Dow 200.10 silicone oil
- Dow 200.20 silicone oil
- Dow 710 silicone oil

Fluids are discussed in detail in Section 8.1.

Remove the access hole cover from the bath and check the tank for foreign matter (dirt, remnant packing material, etc.). Use clean unpolluted fluid. Carefully fill the bath through the large square access hole to a level that will allow for stirring and thermal expansion. The fluid should never exceed a height of 1/2" below the top of the tank. Carefully monitor the bath fluid level as the bath temperature rises to prevent overflow or splashing. Remove excess hot fluid if necessary with caution.

Use caution to prevent bath fluid from spilling on the stirring motor while filling.



NOTE: Under filling may reduce bath performance and may possibly damage the bath heater.

5.4 Probe

Inspect the bath control probe. It should not be bent or damaged in any way. Reasonable caution should be used in handling this probe as it contains a precision platinum sensor and is mechanically shock sensitive. Dropping, striking, or other physical shock may cause a shift in resistance in the probe resulting in diminished bath accuracy. If damaged, the probe can be replaced. Contact an Authorized Service Center (see Section 1.3) for assistance.

Insert the probe into the 1/4 inch probe hole at the top left side of the bath lid. The tip of the probe must be well immersed in the fluid. The probe connector is plugged into the rear of the bath into the socket labeled “PROBE”.

5.5 Power

With the bath power switch off, plug the bath into an AC mains outlet of the appropriate voltage, frequency, and current capacity. See Section 3.1, Specifications.

Be sure the stirring motor power cord is plugged into the “STIRRER” socket at the back of the bath.

5.6 Tipping Prevention Brackets Installation (6024 with model 2072 cart only)



WARNING: Hart Scientific recommends installing the bath on a heat-resistant non-flammable surface.

In order to create the safest possible conditions under use, the bath comes equipped with Tipping Prevention Brackets. The installation of the brackets is required for compliance with the *International Safety Standard IEC 61010-1, Section 7.3, Stability*, which applies to the stability of the bath under normal operating conditions.

5.6.1 Installation on a Concrete Floor

Using a concrete drill and concrete drill bit, drill three 1/4 inch x 1 1/4 inch deep (approximately 6.5 mm x 32 mm) holes in the concrete floor using the bracket to mark the hole placement. Drop the flare anchor bolt into the hole. Tightening the screw expands the anchor in the drilled hole and secures the bracket. Ensure that the bracket is installed in such a way as to ensure the bath will have a minimum of 6 inches of clearance for air circulation (see Figure 2). Screw the brackets securely to the floor.

5.6.2 Installation of the Bath

Slide the back casters of the bath completely into the bracket caster slots (see Figure 2). Lock the front casters of the bath. Check that the bath is securely locked into the brackets by gently pushing on the bath. Proceed to fill the bath with the applicable bath fluid after reading the entire User's Guide. If you have any questions concerning installation of the tipping prevention brackets, please contact a Hart Authorized Service Center (see Section 1.3).

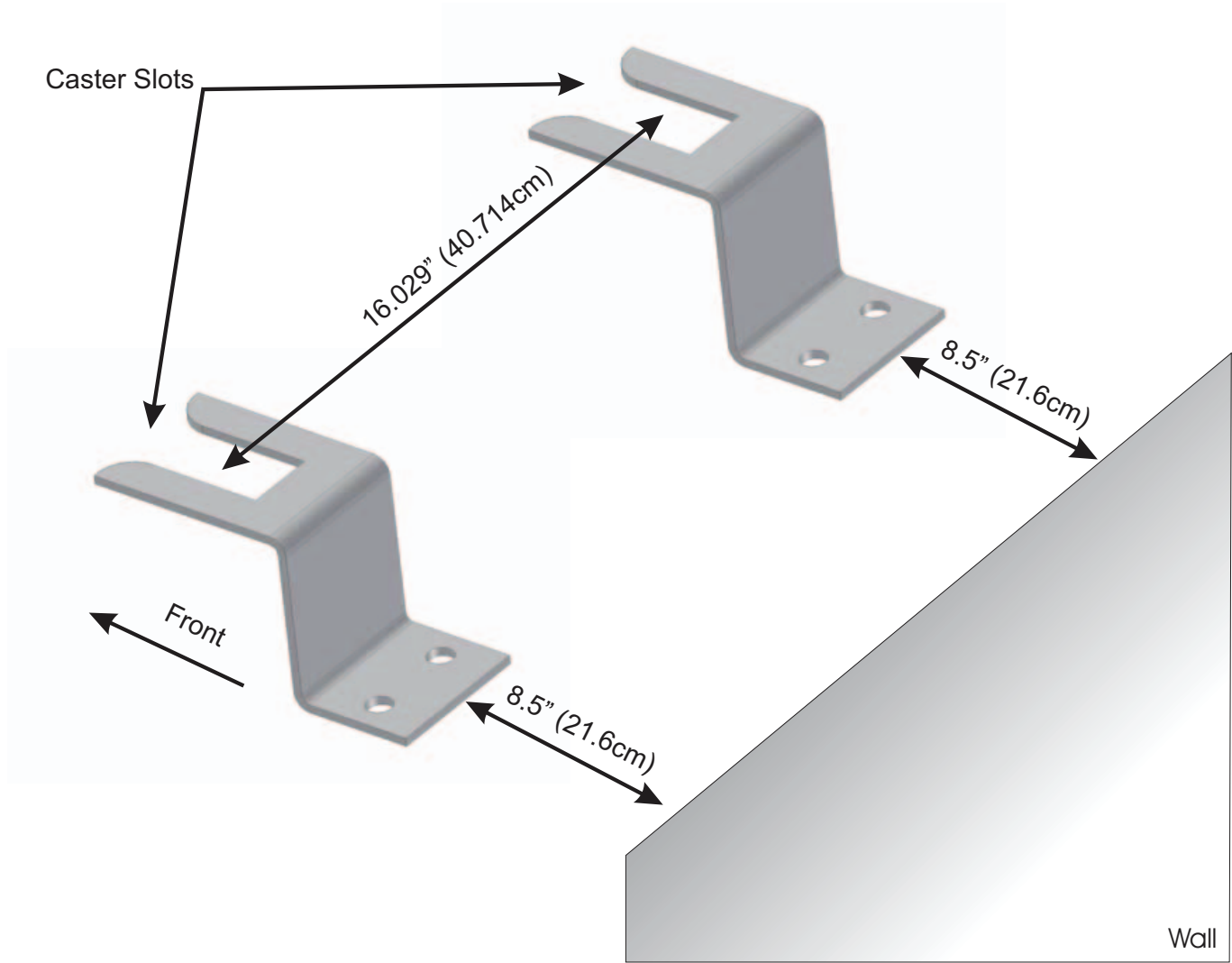

Figure 2 Tipping Prevention Bracket Installation

6 Bath Use



CAUTION: Read before placing the bath in service.

The information in this section is for general information only. It is not designed to be the basis for calibration laboratory procedures. Each laboratory will need to write their own specific procedures.

6.1 General

Be sure to select the correct fluid for the temperature range of the calibration. Bath fluids should be selected to operate safely with adequate thermal properties to meet the application requirements. Also, be aware that some fluids expand and could overflow the bath if not watched. Refer to General Operation, section 8, for information specific to fluid selection and to the MSDS sheet specific to the fluid selected. Generally, baths are set to one temperature and used to calibrate probes only at that single temperature. This means that the type of bath fluid does not have to change. Additionally, the bath can be left energized reducing the stress on the system.

The bath generates extreme temperatures. Precautions must be taken to prevent personal injury or damage to objects. Probes may be extremely hot or cold when removed from the bath. Cautiously handle probes to prevent personal injury. Carefully place probes on a heat/cold resistant surface or rack until they are at room temperature. It is advisable to wipe the probe with a clean soft cloth or paper towel before inserting it into another bath. This prevents the mixing of fluids from one bath to another. If the probe has been calibrated in liquid salt, carefully wash the probe in warm water and dry completely before transferring it to another fluid. Always be sure that the probe is completely dry before inserting it into a hot fluid. Some of the high temperature fluids react violently to water or other liquid mediums. Be aware that cleaning the probe can be dangerous if the probe has not cooled to room temperature. Additionally, high temperature fluids may ignite the paper towels if the probe has not been cooled.

For optimum accuracy and stability, allow the bath adequate stabilization time after reaching the set-point temperature.

6.2 Comparison Calibration

Comparison calibration involves testing a probe (unit under test, UUT) against a reference probe. After inserting the probes to be calibrated into the bath, allow sufficient time for the probes to settle and the temperature of the bath to stabilize.

One of the significant dividends of using a bath rather than a dry-well to calibrate multiple probes is that the probes do not need to be identical in construction. The fluid in the bath allows different types of probes to be calibrated at

the same time. However, stem effect from different types of probes is not totally eliminated. Even though all baths have horizontal and vertical gradients, these gradients are minimized inside the bath work area. See Section 7.2 entitled Bath Tank and Lid. Nevertheless, probes should be inserted to the same depth in the bath liquid. Be sure that all probes are inserted deep enough to prevent stem effect. From research at Hart Scientific, we suggest a general rule-of-thumb for immersion depth to reduce the stem effect to a minimum: 15 x the diameter of the UUT + the sensor length. **Do not submerge the probe handles.** If the probe handles get too warm during calibration at high temperatures, a heat shield could be used just below the probe handle. This heat shield could be as simple as aluminum foil slid over the probe before inserting it in the bath or as complicated as a specially designed reflective metal apparatus.

When calibrating over a wide temperature range, better results can generally be achieved by starting at the highest temperature and progressing down to the lowest temperature.

Probes can be held in place in the bath by using probe clamps or drilling holes in the access cover. Other fixtures to hold the probes can be designed. The object is to keep the reference probe and the probe(s) to be calibrated as closely grouped as possible in the working area of the bath. Bath stability is maximized when the bath working area is kept covered.

In preparing to use the bath for calibration start by:

- Placing the reference probe in the bath working area.
- Placing the probe to be calibrated, the UUT, in the bath working area as close as feasibly possible to the reference probe.

6.3 Calibration of Multiple Probes

Fully loading the bath with probes increases the time required for the temperature to stabilize after inserting the probes. Using the reference probe as the guide, be sure that the temperature has stabilized before starting the calibration.

7 Parts and Controls

Refer to the Appendix specific to your bath model for additional information on parts and controls.

7.1 Front Panel

The following controls and indicators are present on the controller front panel (see Figure 3 below): (1) the digital LED display, (2) the control buttons, (3) the bath on/off power switch, (4) the control indicator light, and (5) the heater power switch.

(1) The digital display is an important part of the temperature controller because it not only displays set and actual temperatures but also various bath functions, settings, and constants. The display shows temperatures in values according to the selected scale units °C or °F.

(2) The control buttons (SET, DOWN, UP, and EXIT) are used to set the bath temperature set-point, access and set other operating parameters, and access and set bath calibration parameters.

A brief description of the functions of the buttons follows:

SET – Used to display the next parameter in a menu and to set parameters to the displayed value.

DOWN – Used to decrement the displayed value of settable parameters.

UP – Used to increment the displayed value.

EXIT – Used to exit from a menu. When EXIT is pressed any changes made to the displayed value will be ignored.

(3) The on/off switch controls power to the entire bath assembly. It powers the stirring motor and the bath controller/heater circuit.



Figure 3 Front Panel Features

(4) The control indicator is a two color light emitting diode. This indicator lets the user visually see the ratio of heating to cooling. When the indicator is red the heater is on, and when it is green the heater is off and the bath is cooling.

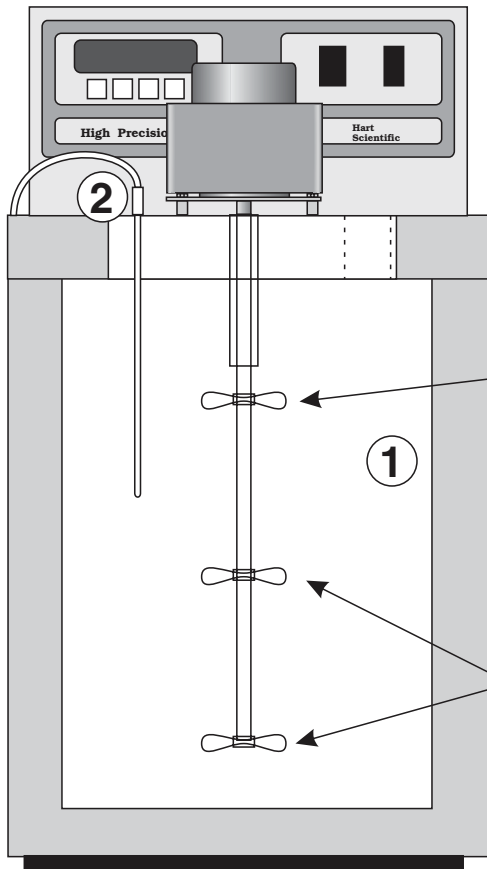
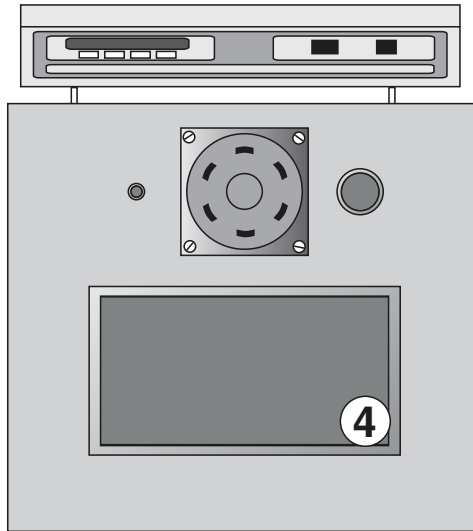

6021, 6022
only

6020, 6021,
6022, 6024

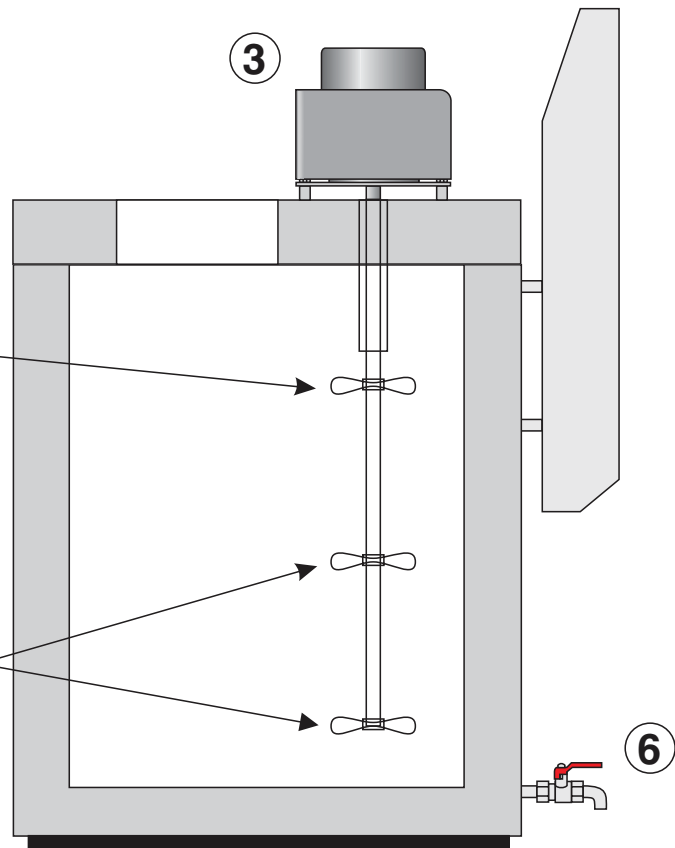

Figure 4 Typical 6020 Series Calibration Bath

(5) The heater power switch is used to select the appropriate heater power levels for heating and controlling temperatures.

7.2 Bath Tank and Lid

The bath tank and lid assembly includes: (1) the tank, (2) the control probe, (3) the stir motor, (4) the access hole, (5) the access hole cover, and (6) the bath drain. (See Figure 4 on page 24.)

(1) The bath tank is constructed of stainless steel and is very resistant to oxidation in the presence of most chemicals and over a wide range of temperatures.

(2) The control probe provides temperature feedback signal to the controller allowing the controller to maintain a constant temperature. The control probe is a precision platinum resistance thermometer (PRT). The control probe is delicate and must be handled carefully. The probe is placed in the small hole in the top of the bath so that the probe tip is fully immersed in the bath fluid. The probe cable connects to the bath at the probe connector on the back panel.

(3) The stir motor is mounted on the bath tank lid. It drives the stirring propeller to provide mixing of the bath fluid. Proper mixing of the fluid is important for good constant temperature stability. The stir motor power cord plugs into the back of the bath at the power socket labeled “STIRRER”.

(4) On the bath lid is a large rectangular access hole. This hole is used for filling and emptying the bath with fluids and placement of thermometers and devices into the bath. When possible the access hole should be covered. The **working area** is defined as one inch from the sides and bottom and three inches from the top of the fluid.

(5) An access hole cover is recommended to cover the large square access opening in the top of the bath. This improves bath temperature stability, prevents excess fluid evaporation or fumes and increases safety with hot fluid. The user may drill or cut holes in the cover to accommodate the instruments to be calibrated or immersed in the bath. Spare covers are available from Hart Scientific.

(6) A drain valve is provided for ease of removing the fluid media from the bath. Always use a container of adequate size to hold the **full load** of fluid. Some oils are more easily drained at higher temperatures. (See caution note below.)



CAUTION: *Extreme caution must be maintained to prevent harm to the user or the surrounding environment. Do not exceed a 120°C fluid temperature for draining. The valve could be damaged if 120°C is exceeded. Insulate the container from the floor or other objects that may be damaged by high temperatures as required.*

7.3 Back Panel

The back panel of the bath contains the following features: (1) the bath power cord, (2) the stir motor power socket, (3) the system fuses (located internally), (4) the probe socket, (5) the RS-232 interface connector (optional), (6) the IEEE-488 interface connector (optional), (7) the cooling tubes, and (8) the bath drain. (See Figure 5 on page 26.)

(1) The bath power cord extends from the back of the bath. It provides power for the bath temperature controller, the heaters, and the stir motor. The cord is plugged into an AC mains socket of appropriate voltage and current. See Section 3.1, Specifications for specific details.

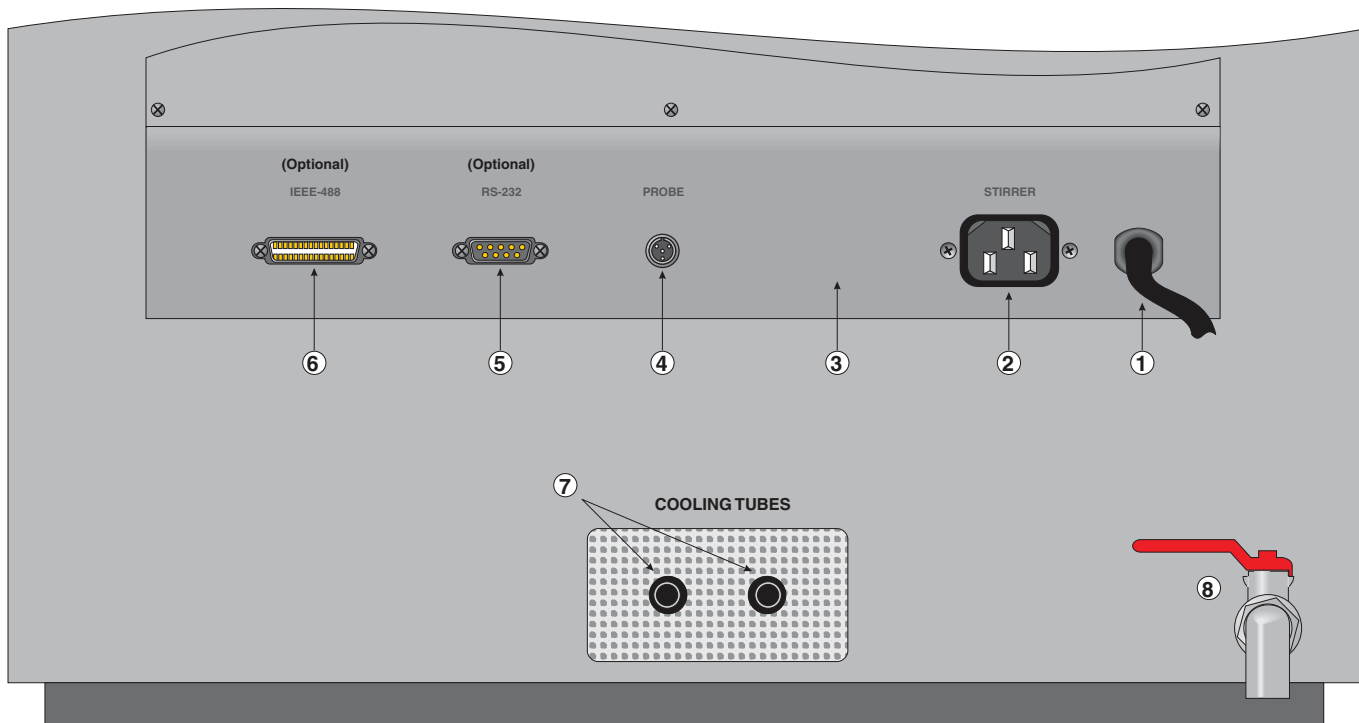

Figure 5 Back Panel

- (2) The stir motor power cord plugs into the socket labeled “STIRRER”. Power to the stir motor is switched on by the POWER switch on the control panel.
- (3) The system fuses are located internally. Never replace the fuse with one of a rating greater than that specified.
- (4) The control probe plugs into the bath at the socket on the back of the bath labeled “PROBE”.
- (5) If the bath is supplied with a serial RS-232 interface, the interface cable is attached to the back of the bath at the connector labeled “RS-232”.
- (6) If the bath is supplied with a GPIB IEEE-488 interface, the interface cable is attached to the back of the bath at the connector labeled “IEEE-488”.

(7) The cooling tubes protrude from the bottom of the back of the bath. Cooling fluid may be circulated around the bath by pumping fluid through the tubes.

(8) A drain valve is provided for ease of removing the fluid media from the bath. Always use a container of adequate size to hold the **full load** of fluid. Some oils are more easily drained at higher temperatures. (See caution note above.)

8 General Operation

8.1 Bath Fluid

Many fluids work with the 6020 series baths. Choosing a fluid requires consideration of many important characteristics of the fluid. Among these are temperature range, viscosity, specific heat, thermal conductivity, thermal expansion, electrical resistivity, fluid lifetime, safety, and cost.

8.1.1 Temperature Range

One of the most important characteristics to consider is the temperature range of the fluid. Few fluids work well throughout the complete temperature range of the bath. The temperature at which the bath is operated must always be within the safe and useful temperature range of the fluid. The lower temperature range of the fluid is determined by the freeze point of the fluid or the temperature at which the viscosity becomes too great. The upper temperature is usually limited by vaporization, flammability, or chemical breakdown of the fluid. Vaporization of the fluid at higher temperatures may affect temperature stability because of cool condensed fluid dripping into the bath from the lid.

The bath temperature should be limited by setting the safety cutout so that the bath temperature cannot exceed the safe operating temperature limit of the fluid.

8.1.2 Viscosity

Viscosity is a measure of the thickness of a fluid, how easily it can be poured and mixed. Viscosity affects the temperature stability of the bath. With low viscosity, fluid mixing is better which creates a more uniform temperature throughout the bath. This improves the bath response time which allows it to maintain a more constant temperature. For good control the viscosity should be less than 10 centistokes. 50 centistokes is about the upper limit of allowable viscosity. Viscosities greater than this cause very poor control stability and may also overheat or damage the stirring motor. With oils viscosity may vary greatly with temperature.

When using fluids with higher viscosities the controller proportional band may need to be increased to compensate for the reduced response time. Otherwise the temperature may begin to oscillate.

8.1.3 Specific Heat

Specific heat is the measure of the heat storage ability of the fluid. Specific heat, to a small degree, affects the control stability. It also affects the heating and cooling rates. Generally, a lower specific heat means quicker heating and cooling. The proportional band may require some adjustment depending on the specific heat of the fluid.

8.1.4 Thermal Conductivity

Thermal conductivity measures how easily heat flows through the fluid. Thermal conductivity of the fluid affects the control stability, temperature uniformity, and probe temperature settling time. Fluids with higher conductivity distribute heat more quickly and evenly improving bath performance.

8.1.5 Thermal Expansion

Thermal expansion describes how the volume of the fluid changes with temperature. Thermal expansion of the fluid used must be considered since the increase in fluid volume as the bath temperature changes may cause overflow. Excessive thermal expansion may also be undesirable in applications where constant liquid level is important. Many fluids including oils have significant thermal expansion.

8.1.6 Electrical Resistivity

Electrical resistivity describes how well the fluid insulates against the flow of electric current. In some applications, such as measuring the resistance of bare temperature sensors, it may be important that little or no electrical leakage occur through the fluid. In such conditions choose a fluid with very high resistivity.

8.1.7 Fluid Lifetime

Many fluids degrade over time because of evaporation, water absorption, gelling, or chemical breakdown. Often the degradation becomes significant near the upper temperature limit of the fluid, substantially reducing the fluid's lifetime.

8.1.8 Safety

When choosing a fluid always consider the safety issues associated. Obviously where there are conditions of extreme hot or cold there can be danger to people and equipment. Fluids may also be hazardous for other reasons. Some fluids may be considered toxic. Contact with eyes, skin, or inhalation of vapors may cause injury. A proper fume hood must be used if hazardous or bothersome vapors are produced.



WARNING: *Fluids at high temperatures may pose danger from BURNS, FIRE, and TOXIC FUMES. Use appropriate caution and safety equipment.*

Fluids may be flammable and require special fire safety equipment and procedures. An important characteristic of the fluid to consider is the flash point. The flash point is the temperature at which there is sufficient vapor given off so that when there is sufficient oxygen present and an ignition source is applied the vapor will ignite. This does not necessarily mean that fire will be sustained at the

flash point. The flash point may be either of the open cup or closed cup type. Either condition may occur in a bath situation. The closed cup temperature is always the lower of the two. The closed cup represents the contained vapors inside the tank and the open cup represents the vapors escaping the tank. Oxygen and an ignition source will be less available inside the tank.

Environmentally hazardous fluids require special disposal according to applicable federal or local laws after use.

8.1.9 Cost

Cost of bath fluids may vary greatly, from cents per gallon for water to hundreds of dollars per gallon for synthetic oils. Cost may be an important consideration when choosing a fluid.

8.1.10 Commonly Used Fluids

Below is a description of some of the more commonly used fluids and their characteristics.

8.1.10.1 Water

Water is often used because of its very low cost, availability, and excellent temperature control characteristics. Water has very low viscosity and good thermal conductivity and heat capacity which makes it among the best fluids for control stability at low temperatures. Temperature stability is much poorer at higher temperatures because water condenses on the lid, cools and drips into the bath. Water is safe and relatively inert. The electrical conductivity of water may prevent its use in some applications. Water has a limited temperature range, from a few degrees above 0°C to a few degrees below 100°C. At higher temperatures evaporation becomes significant. Water used in the bath should be distilled or softened to prevent mineral deposits. Consider using an algicide chemical in the water to prevent contamination.

8.1.10.2 Ethylene Glycol

The temperature range of water may be extended by using a solution of 1 part water and 1 part ethylene glycol (antifreeze). The characteristics of the ethylene glycol-water solution are similar to water. Use caution with ethylene glycol since the fluid is very toxic. Ethylene glycol must be disposed of properly.

8.1.10.3 Mineral Oil

Mineral oil or paraffin oil is often used at moderate temperatures above the range of water. Mineral oil is relatively inexpensive. At lower temperatures mineral oil is quite viscous and control may be poor. At higher temperatures vapor emission becomes significant. The vapors may be dangerous and use of a fume hood is highly recommended. As with most oils, mineral oil expands as temperature increases so be careful not to fill the bath too full that it overflows when heated. The viscosity and thermal characteristics of mineral oil is poorer

than water so temperature stability is not be as good. Mineral oil has very low electrical conductivity. Use caution with mineral oil since it is flammable and may also cause serious injury if inhaled or ingested.

8.1.10.4 Silicone Oil

Silicone oils are available which offer a much wider operating temperature range than mineral oil. Like most oils, silicone oils have temperature control characteristics which are somewhat poorer than water. The viscosity changes significantly with temperature and thermal expansion also occurs. These oils have very high electrical resistivity. Silicone oils are fairly safe and non-toxic. Silicone oils are fairly expensive.

8.1.11 Fluid Characteristics Charts

Table 2 and Figure 6 on pages 33 and 34 have been created to provide help in selecting a heat exchange fluid media for your constant temperature bath. These charts provide both a visual and numerical representation of most of the physical qualities important in making a selection. The list is not all inclusive. There may be other useful fluids not shown in this listing.

The charts include information on a variety of fluids which are often used as heat transfer fluid in baths. Because of the temperature range some fluids may not be useful with your bath.

8.1.11.1 Limitations and Disclaimer

The information given in this manual regarding fluids is intended only to be used as a general guide in choosing a fluid. Though every effort has been made to provide correct information we cannot guarantee accuracy of data or assure suitability of a fluid for a particular application. Specifications may change and sources sometimes offer differing information. Hart Scientific cannot be liable for any personal injury or damage to equipment, product or facilities resulting from the use of these fluids. The user of the bath is responsible for collecting correct information, exercising proper judgement, and insuring safe operation. Operating near the limits of certain properties such as the flash point or viscosity can compromise safety or performance. Your company's safety policies regarding flash points, toxicity, and such issues must be considered. You are responsible for reading the MSDS (material safety data sheets) and acting accordingly.

8.1.11.2 About the Graph

The fluid graph visually illustrates some of the important qualities of the fluids shown.

Temperature Range: The temperature scale is shown in degrees Celsius. The fluids' general range of application is indicated by the shaded bands. Qualities including pour point, freeze point, important viscosity points, flash point, boiling point and others may be shown.

Table 2 Table of Various Fluids and Their Properties

Fluid (# = Hart Part No.)	Lower Temperature Limit*	Upper Temperature Limit*	Flash Point	Viscosity (centistokes)	Specific Gravity	Specific Heat (cal/g°C)	Thermal Conductivity (cal/s/cm°C)	Thermal Expansion (cm/cm°C)	Resistivity (10 ¹² Ω-cm)
Halocarbon 0.8 #5019	-90°C (v)**	70°C (e)	NONE	5.7 @ -50°C 0.8 @ 40°C 0.5 @ 70°C	1.71 @ 40°C	0.2	0.0004	0.0011	
Methanol	-96°C (fr)	60°C (b)	54°C	1.3 @ -35°C 0.66 @ 0°C 0.45 @ 20°C	0.810 @ 0°C 0.792 @ 20°C	0.6	0.0005 @ 20°C	0.0014 @ 25°C	
Water	0°C (fr)	95°C (b)	NONE	1 @ 25°C 0.4 @ 75°C	1.00	1.00	0.0014	0.0002 @ 25°C	
Ethylene Glycol—50% #5020	-35°C (fr)	90°C (b)	NONE	7 @ 0°C 2 @ 50°C 0.7 @ 100°C	1.05	0.8 @ 0°C	0.001		
Mineral Oil #5011	40°C (v)	190°C (fl)	190°C	15 @ 75°C 5 @ 125°C	0.87 @ 25°C 0.84 @ 75°C 0.81 @ 125°C	0.48 @ 25°C 0.53 @ 75°C 0.57 @ 125°C	0.00025 @ 25°C	0.0007 @ 50°C	5 @ 25°C
Dow Corning 200.5 Silicone Oil	-40°C (v)**	133°C (fl, cc)	133°C	5 @ 25°C	0.92 @ 25°C	0.4	0.00028 @ 25°C	0.00105	1000 @ 25°C 10 @ 150°C
Dow Corning 200.10 #5012	-35°C (v)**	165°C (fl, cc)	165°C	10 @ 25°C 3 @ 135°C	0.934 @ 25°C	0.43 @ 40°C 0.45 @ 100°C 0.482 @ 200°C	0.00032 @ 25°C	0.00108	1000 @ 25°C 50 @ 150°C
Dow Corning 200.20 #5013	7°C (v)	230°C (fl, cc)	230°C	20 @ 25°C	0.949 @ 25°C	0.370 @ 40°C 0.393 @ 100°C 0.420 @ 200°C	0.00034 @ 25°C	0.00107	1000 @ 25°C 50 @ 150°C
Dow Corning 200.50 Silicone Oil #5014	25°C (v)	280°C (fl, cc)	280°C	20 @ 25°C	0.96 @ 25°C	0.4	0.00037 @ 25°C	0.00104	1000 @ 25°C 50 @ 150°C
Dow Corning 550 #5016	70°C (v)	232°C (fl, cc) 300°C (fl, cc)	232°C	50 @ 70°C 10 @ 104°C	1.07 @ 25°C	0.358 @ 40°C 0.386 @ 100°C 0.433 @ 200°C	0.00035 @ 25°C	0.00075	100 @ 25°C 1 @ 150°C
Dow Corning 710 #5017	80°C (v)	302°C (fl, cc)	302°C	50 @ 80°C 7 @ 204°C	1.11 @ 25°C	0.363 @ 40°C 0.454 @ 100°C 0.505 @ 200°C	0.00035 @ 25°C	0.00077	100 @ 25°C 1 @ 150°C
Dow Corning 210-H Silicone Oil	66°C (v)	315°C (fl, cc)	315°C	50 @ 66°C 14 @ 204°C	0.96 @ 25°C	0.34 @ 100°C	0.0003	0.00095	100 @ 25°C 1 @ 150°C
Heat Transfer Salt #5001	145°C (fr)	530°C	NONE	34 @ 150°C 6.5 @ 300°C 2.4 @ 500°C	2.0 @ 150°C 1.9 @ 300°C 1.7 @ 500°C	0.33	0.0014	0.00041	1.7 Ω /cm ³

*Limiting Factors — b - boiling point e - high evaporation fl - flash point fr - freeze point v - viscosity — Flash point test oc = open cup cc = closed cup

**Very low water solubility, ice will form as a slush from condensation below freezing.

Freezing Point: The freezing point of a fluid is an obvious limitation to stirring. As the freezing point is approached high viscosity may also limit performance.

Pour Point: This represents a handling limit for the fluid.

Viscosity: Points shown are at 50 and 10 centistokes viscosity. When viscosity is greater than 50 centistokes stirring is very poor and the fluid is unsatisfactory for bath applications. Optimum stirring generally occurs at 10 centistokes and below.

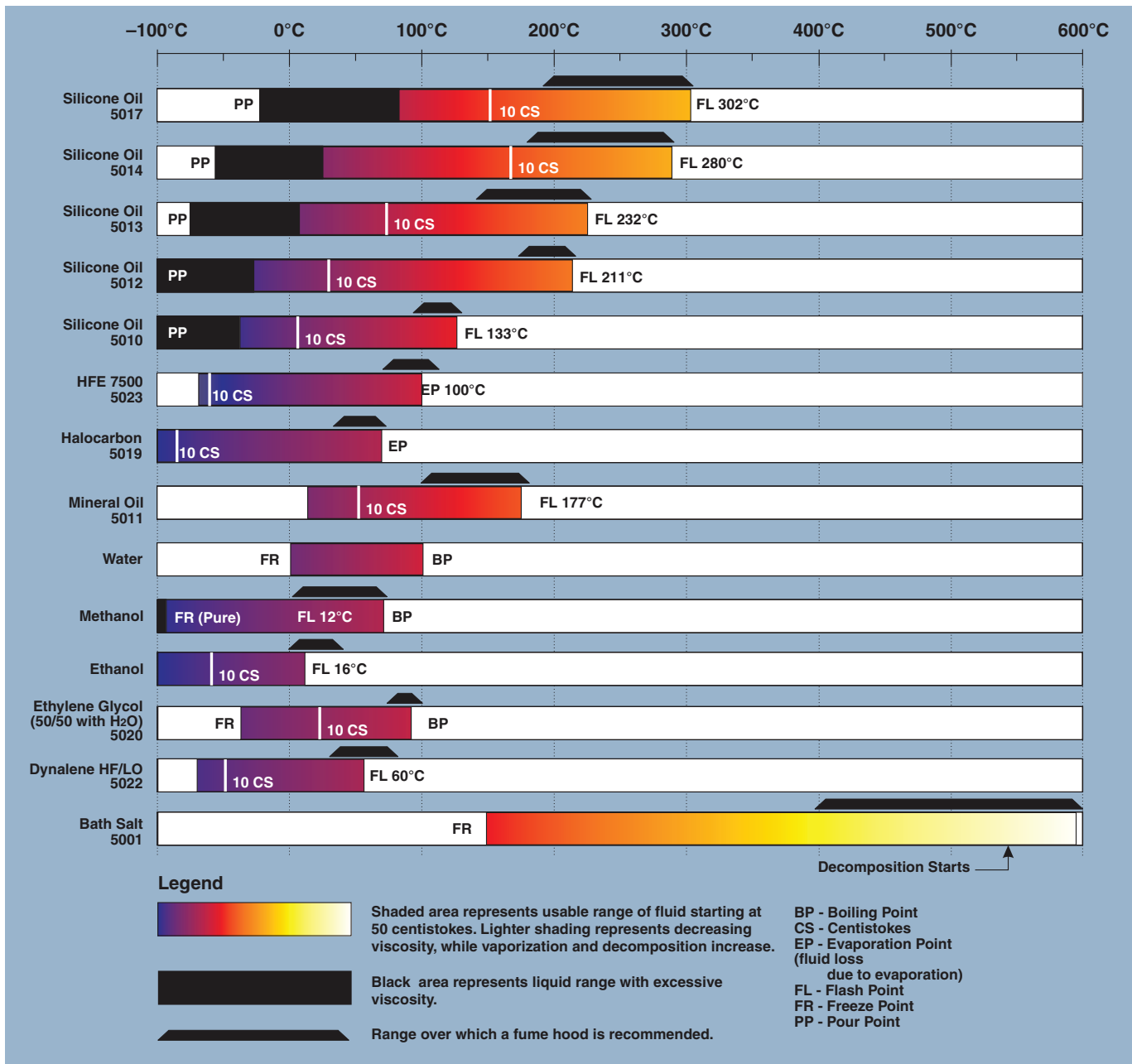

Figure 6 Chart of Various Bath Fluids

Fume Point: A fume hood should be used. This point is very subjective in nature and is impacted by individual tolerance to different fumes and smells, how well the bath is covered, the surface area of the fluid in the bath, the size and ventilation of the facility where the bath is located and other conditions. We assume the bath is well covered at this point. This is also subject to company policy.

Flash Point: The point at which ignition may occur. The point shown may be either the open or closed cup flash point. Refer to the flash point discussion in Section 8.1.8.

Boiling Point: At or near the boiling point of the fluid, the temperature stability is difficult to maintain. Fuming or evaporation is excessive. Large amounts of heater power may be required because of the heat of vaporization.

Decomposition: The temperature may reach a point at which decomposition of the fluid begins. Further increasing the temperature may accelerate decomposition to the point of danger or impracticality.

8.2 Stirring

Stirring of the bath fluid is very important for stable temperature control. The fluid must be mixed well for good temperature uniformity and fast controller response. The stirrer is precisely adjusted for optimum performance.

8.3 Power

Power to the bath is provided by an AC mains supply. See Section 3.1, Specifications, for additional details. Power to the bath passes through a filter to prevent switching spikes from being transmitted to other equipment.

To turn on the bath switch the control panel power switch to the ON position. The stir motor will turn on, the LED display will begin to show the bath temperature, and the heater will turn on or off until the bath temperature reaches the programmed set-point.

When powered on the control panel display will briefly show a four digit number. This number indicates the number of times power has been applied to the bath. Also briefly displayed is data which indicates the controller hardware configuration. This data is used in some circumstances for diagnostic purposes.

8.4 Heater

The power to the bath heater is precisely controlled by the temperature controller to maintain a constant bath temperature. Power is controlled by periodically switching the heater on for a certain amount of time using a solid-state relay.

The front panel red/green control indicator shows the state of the heater. The control indicator glows red when the heater is on and glows green when the heater is off. The indicator will pulse constantly when the bath is maintaining a stable temperature.

The heater has two power level settings. The “HIGH” heater power setting is used to quickly heat up the bath fluid to the desired operating temperature. The “HIGH” heater power setting may also be required for control at high temperatures. The “LOW” setting is used for control at lower temperatures and for scanning at slower rates. When controlling at the “HIGH” heater power setting instead of “LOW” the proportional band may need to be increased (typically by a factor of four) to compensate for the increase in power gain. Otherwise the temperature may oscillate.

Heater fuses are located internally. See Section 13, Troubleshooting, for more information

8.5 Cooling



WARNING: *Do not use cooling water at temperatures approaching 100°C. When operating the bath at these high temperatures make sure the hoses are disconnected and completely drained, otherwise there may be danger of steam explosion.*

Cooling water or other external coolant circulates beneath the bottom of the bath tank to provide cooling. The cooling fluid must be of constant temperature and flow rate for good temperature stability. For optimum control stability the temperature difference between the cooling water and bath fluid should be about 20°C. Temperatures for this fluid below 15°C are not recommended.

Attach ¼ inch I.D. hose lines to the tubes protruding from the back of the bath. Fasten the hoses tightly with hose clamps. Cooling fluid pressure should not exceed the capability of the lines attached. Connect a valve in line with the cooling water to regulate the flow rate. Run the outlet line to a drain or tank.

The cooling fluid must match the properties required for the bath temperature. Fluids should have the same safety margin and careful consideration as any fluid used in the bath.

8.6 Temperature Controller

The bath temperature is controlled by Hart Scientific's unique hybrid digital/analog temperature controller. The controller offers the tight control stability of an analog temperature controller as well as the flexibility and programmability of a digital controller.

The bath temperature is monitored with a platinum resistance sensor in the control probe. The signal is electronically compared with the programmable reference signal, amplified, and then fed to a pulse-width modulator circuit which controls the amount of power applied to the bath heater.

The bath is operable within the temperature range given in the specifications. For protection against solid-state relay failure or other circuit failure, the micro-controller will automatically turn off the heater with a second mechanical relay anytime the bath temperature is more than a certain amount above the set-point temperature. As a second protection device, the controller is also equipped with a separate thermocouple temperature monitoring circuit which will shut off the heater if the temperature exceeds the cutout set-point.

The controller allows the operator to set the bath temperature with high resolution, set the cutout, adjust the proportional band, monitor the heater output power, and program the controller configuration and calibration parameters. The controller may be operated in temperature units of degrees Celsius or Fahr-

enheit. The controller is operated and programmed from the front control panel using the four key switches and digital LED display. The controller may also be optionally equipped with an serial RS-232 or IEEE-488 GPIB digital interface for remote operation. Operation of the controller using the front control panel is discussed in Section 9. Operation using the digital interfaces is discussed in Section 10.

When the controller is set to a new set-point the bath will heat or cool to the new temperature. Once the new temperature is reached the bath usually takes 10-15 minutes for the temperature to settle and stabilize. There may be a small overshoot or undershoot of about 0.5°C.

9 Controller Operation

This section discusses in detail how to operate the bath temperature controller using the front control panel. Using the front panel key switches and LED display the user may monitor the bath temperature, set the temperature set-point in degrees C or F, monitor the heater output power, adjust the controller proportional band, set the cutout set-point, and program the probe calibration parameters, operating parameters, serial and IEEE-488 interface configuration, and controller calibration parameters. operation is summarized in Figure 7 on page 40.

9.1 Bath temperature

The digital LED display on the front panel allows direct viewing of the actual bath temperature. This temperature value is what is normally shown on the display. The units, C or F, of the temperature value are displayed at the right. For example,

 *Bath temperature in degrees Celsius*

The temperature display function may be accessed from any other function by pressing the “EXIT” button.

9.2 Reset Cutout

If the over-temperature cutout has been triggered then the temperature display will alternately flash,

 *Indicates cutout condition*

The message continues to flash until the temperature is reduced and the cutout is reset.

The cutout has two modes — automatic reset and manual reset. The mode determines how the cutout is reset which allows the bath to heat up again. When in automatic mode, the cutout resets itself as soon as the temperature is lowered below the cutout set-point. With manual reset mode, the cutout must be reset by the operator after the temperature falls below the set-point.

When the cutout is active and the cutout mode is set to manual “r E S E T”, the display flashes “c u t o u t” until the user resets the cutout. To access the reset cutout function press the “SET” button.

 *Access cutout reset function*

The display indicates the reset function.

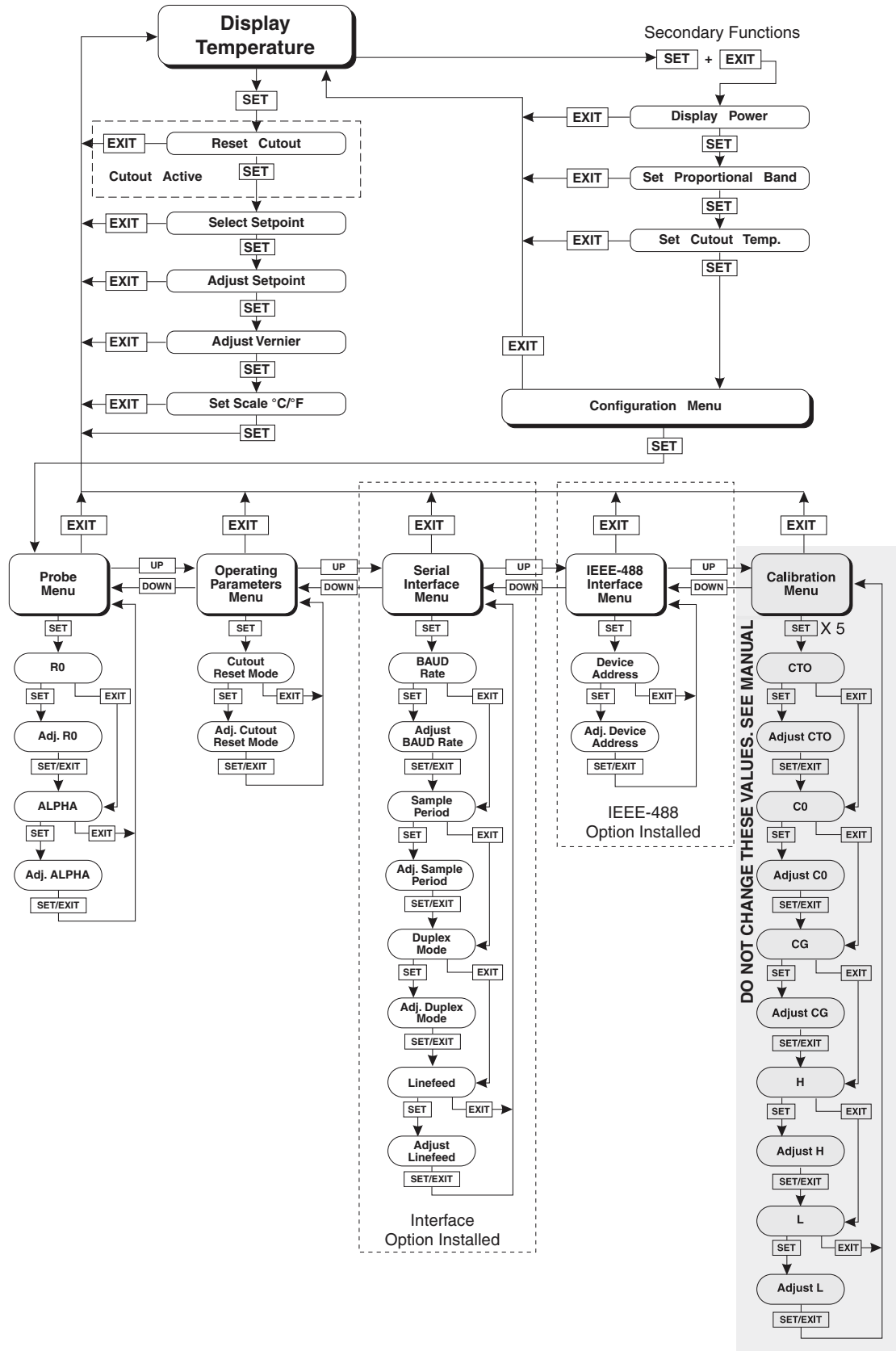

Figure 7 Controller Operation Flowchart

 *Cutout reset function*

Press “SET” once more to reset the cutout.

 *Reset cutout*

This also switches the display to the set temperature function. To return to displaying the temperature press the “EXIT” button. If the cutout is still in the over-temperature fault condition the display continues to flash “c u t o u t”. The bath temperature must drop a few degrees below the cutout set-point before the cutout can be reset.

9.3 Temperature Set-point

The bath temperature can be set to any value within the range and with resolution as given in the specifications. The temperature range of the particular fluid used in the bath must be known by the operator and the bath should only be operated well below the upper temperature limit of the liquid. In addition, the cutout temperature should also be set below the upper limit of the fluid.

Setting the bath temperature involves three steps: (1) select the set-point memory, (2) adjust the set-point value, and (3) adjust the vernier if desired.

9.3.1 Programmable Set-points

The controller stores 8 set-point temperatures in memory. The set-points can be quickly recalled to conveniently set the bath to a previously programmed temperature set-point.

To set the bath temperature one must first select the set-point memory. This function is accessed from the temperature display function by pressing “SET”. The number of the set-point memory currently being used is shown at the left on the display followed by the current set-point value.

 *Bath temperature in degrees Celsius*

 *Access set-point memory*

 *Set-point memory 1, 25.0°C currently used*

To change the set-point memory press “UP” or “DOWN”.

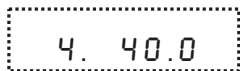
 *New set-point memory 4, 40.0°C*

Press “SET” to accept the new selection and access the set-point value.

 *Accept selected set-point memory*

9.3.2 Set-point Value

The set-point value may be adjusted after selecting the set-point memory and pressing “SET”. The set-point value is displayed with the units, C or F, at the left.

 *Set-point 4 value in °C*

If the set-point value need not be changed then press “EXIT” to resume displaying the bath temperature. Press “UP” or “DOWN” to adjust the set-point value.

 *New set-point value*

When the desired set-point value is reached press “SET” to accept the new value and access the set-point vernier. If “EXIT” is pressed instead then any changes made to the set-point will be ignored.

 *Accept new set-point value*

9.3.3 Set-point Vernier

The set-point value can only be set with a resolution of 0.01°C. The user may want to adjust the set-point slightly to achieve a precise bath temperature. The set-point vernier allows one to adjust the temperature below or above the set-point by a small amount with very high resolution. Each of the 8 stored set-points has an associated vernier setting. The vernier is accessed from the set-point by pressing “SET”. The vernier setting is displayed as a 6 digit number with five digits after the decimal point. This is a temperature offset in degrees of the selected units, C or F.

 *Current vernier value in °C*

To adjust the vernier press “UP” or “DOWN”. Unlike most functions the vernier setting has immediate effect as the vernier is adjusted. “SET” need not be pressed. This allows one to continually adjust the bath temperature with the vernier as it is displayed.

 *New vernier setting*

Next press “EXIT” to return to the temperature display or “SET” to access the temperature scale units selection.

 *Access scale units*

9.4 Temperature Scale Units

The temperature scale units of the controller may be set by the user to degrees Celsius (°C) or Fahrenheit (°F). The units are used in displaying the bath temperature, set-point, vernier, proportional band, and cutout set-point.

The temperature scale units selection is accessed after the vernier adjustment function by pressing “SET”. From the temperature display function access the units selection by pressing “SET” 4 times.

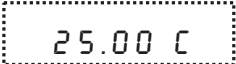
 *Bath temperature*



Access set-point memory

 *Set-point memory*



Access set-point value

 *Set-point value*



Access vernier

 *Vernier setting*



Access scale units selection

 *Scale units currently selected*

Press “UP” or “DOWN” to change the units.

 *New units selected*

Press “SET” to accept the new selection and resume displaying the bath temperature.



Set the new units and resume temperature display

9.5 Secondary Menu

Functions which are used less often are accessed within the secondary menu. The secondary menu is accessed by pressing “SET” and “EXIT” simultaneously and then releasing. The first function in the secondary menu is the heater power display.

9.6 Heater Power

The temperature controller controls the temperature of the bath by pulsing the heater on and off. The total power being applied to the heater is determined by the duty cycle or the ratio of heater on time to the pulse cycle time. This value may be estimated by watching the red/green control indicator light or read directly from the digital display. By knowing the amount of heating to the bath the user can tell if the bath is heating up to the set-point, cooling down, or controlling at a constant temperature. Monitoring the percent heater power will let the user know how stable the bath temperature is. With good control stability the percent heating power should not fluctuate more than $\pm 1\%$ within one minute.

The heater power display is accessed in the secondary menu. Press “SET” and “EXIT” simultaneously and release. The heater power is displayed as a percentage of full power.

 +  *Access heater power in secondary menu*

 *Heater power in percent*

To exit out of the secondary menu press “EXIT”. To continue on to the proportional band setting function press “SET”.

9.7 Proportional Band

In a proportional controller such as this the heater output power is proportional to the bath temperature over a limited range of temperatures around the set-point. This range of temperature is called the proportional band. At the bottom of the proportional band the heater output is 100%. At the top of the proportional band the heater output is 0. Thus as the bath temperature rises the heater power is reduced, which consequently tends to lower the temperature back down. In this way the temperature is maintained at a fairly constant temperature.

The temperature stability of the bath depends on the width of the proportional band. See Figure 8. If the band is too wide the bath temperature will deviate excessively from the set-point due to varying external conditions. This is because the power output changes very little with temperature and the controller cannot respond very well to changing conditions or noise in the system. If the proportional band is too narrow the bath temperature may swing back and forth be-

cause the controller overreacts to temperature variations. For best control stability the proportional band must be set for the optimum width.

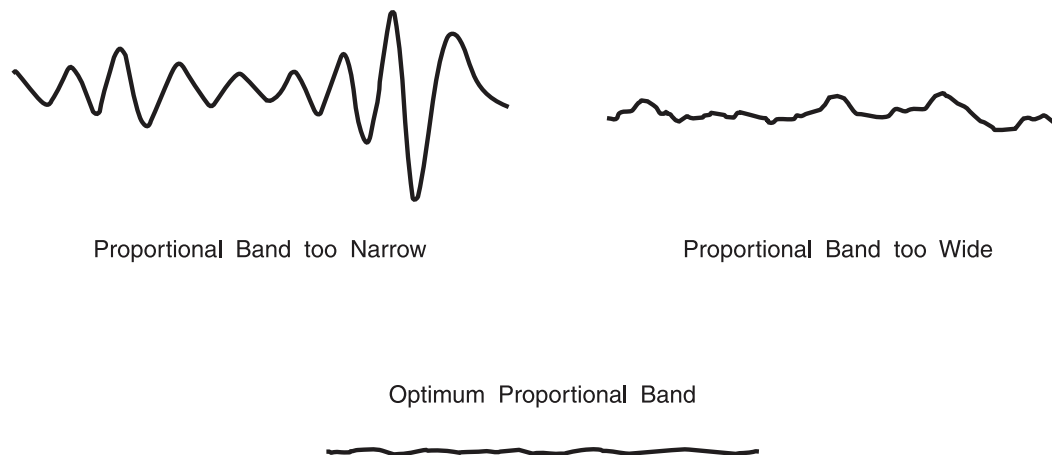

Figure 8 Bath Temperature Fluctuation at Various Proportional Band Settings

The optimum proportional band width depends on several factors among which are fluid volume, fluid characteristics (viscosity, specific heat, thermal conductivity), heater power setting, operating temperature, and stirring. Thus the proportional band width may require adjustment for best bath stability when any of these conditions change. Of these, the most significant factors affecting the optimum proportional band width are heater power setting and fluid viscosity. The proportional band should be wider when the higher power setting is used so that the change in output power per change in temperature remains the same. The proportional band should also be wider when the fluid viscosity is higher because of the increased response time.

The proportional band width is easily adjusted from the bath front panel. The width may be set to discrete values in degrees C or F depending on the selected units. The optimum proportional band width setting may be determined by monitoring the stability with a high resolution thermometer or with the controller percent output power display. Narrow the proportional band width to the point at which the bath temperature begins to oscillate and then increase the band width from this point to 3 or 4 times wider. Table 3 lists typical propor-

tional band settings for optimum performance with a variety of fluids at selected temperatures.

Table 3 Proportional Band — Fluid Table

Fluid	Temperature	Heater Setting	Proportional Band	Stability
Water	30.0°C	Low	0.04°C	±0.0004°C
Water	60.0°C	Low	0.04°C	±0.001°C
Eth-Gly 50%	35.0°C	Low	0.05°C	±0.0005°C
Eth-Gly 50%	60.0°C	Low	0.05°C	±0.001°C
Eth-Gly 50%	100.0°C	High	0.4°C	±0.007°C
Oil	35.0°C	Low	0.1°C	±0.003°C
Oil	60.0°C	Low	0.2°C	±0.002°C
Oil	100°C	Low	0.2°C	±0.003°C
Oil	150°C	Low	0.2°C	±0.004°C
Oil	160°C+	High	0.8°C	±0.01°C

The proportional band adjustment may be accessed within the secondary menu. Press “SET” and “EXIT” to enter the secondary menu and show the heater power. Then press “SET” to access the proportional band.

 +  *Access heater power in secondary menu*

 *Heater power in percent*

 *Access proportional band*

 *Proportional band setting*

To change the proportional band press “UP” or “DOWN”.

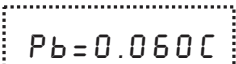
 *New proportional band setting*

To accept the new setting and access the cutout set-point press “SET”. Pressing “EXIT” will exit the secondary menu ignoring any changes just made to the proportional band value.

 *Accept the new proportional band setting*

9.8 Cutout

As a protection against software or hardware fault, shorted heater triac, or user error, the bath is equipped with an adjustable heater cutout device that will shut off power to the heater if the bath temperature exceeds a set value. This protects the heater and bath materials from excessive temperatures and, most importantly, protects the bath fluids from being heated beyond the safe operating temperature preventing hazardous vaporization, breakdown, or ignition of the liquid. The cutout temperature is programmable by the operator from the front panel of the controller. It must always be set below the upper temperature limit of the fluid and no more than 10 degrees above the upper temperature limit of the bath.

If the cutout is activated because of excessive bath temperature then power to the heater will be shut off and the bath will cool. The bath will cool until it reaches a few degrees below the cutout set-point temperature. At this point the action of the cutout is determined by the setting of the cutout mode parameter. The cutout has two selectable modes — automatic reset or manual reset. If the mode is set to automatic, then the cutout will automatically reset itself when the bath temperature falls below the reset temperature allowing the bath to heat up again. If the mode is set to manual, then the heater will remain disabled until the user manually resets the cutout.

The cutout set-point may be accessed within the secondary menu. Press “SET” and “EXIT” to enter the secondary menu and show the heater power. Then press “SET” twice to access the cutout set-point.

 +  *Access heater power in secondary menu*

 *Heater power in percent*

 *Access proportional band*

 *Proportional band setting*

 *Access cutout set-point*

 *Cutout set-point*

To change the cutout set-point press “UP” or “DOWN”.

 *New cutout set-point*

To accept the new cutout set-point press “SET”.

 *Accept cutout set-point*

The next function is the configuration menu. Press “EXIT” to resume displaying the bath temperature.

9.9 Controller Configuration

The controller has a number of configuration and operating options and calibration parameters which are programmable via the front panel. These are accessed from the secondary menu after the cutout set-point function by pressing “SET.” There are 5 sets of configuration parameters — probe parameters, operating parameters, serial interface parameters, IEEE-488 interface parameters, and controller calibration parameters. The menus are selected using the “UP” and “DOWN” keys and then pressing “SET”.

9.10 Probe Parameters

The probe parameter menu is indicated by,

 *Probe parameters menu*

Press “SET” to enter the menu. The probe parameters menu contains the parameters, R_0 and ALPHA, which characterize the resistance-temperature relationship of the platinum control probe. These parameters may be adjusted to improve the accuracy of the bath. This procedure is explained in detail in [Section 11](#).

The probe parameters are accessed by pressing “SET” after the name of the parameter is displayed. The value of the parameter may be changed using the “UP” and “DOWN” buttons. After the desired value is reached press “SET” to set the parameter to the new value. Pressing “EXIT” will cause the parameter to be skipped ignoring any changes that may have been made.

9.10.1 R_0

This probe parameter refers to the resistance of the control probe at 0°C. Normally this is set for 100.000 ohms.

9.10.2 ALPHA

This probe parameter refers to the average sensitivity of the probe between 0 and 100°C. Normally this is set for 0.00385°C⁻¹.

9.11 Operating Parameters

The operating parameters menu is indicated by,

 *Operating parameters menu*

Press “UP” to enter the menu. The operating parameters menu contains the cutout reset mode setting.

9.11.1 Cutout Reset Mode

The cutout reset mode determines whether the cutout resets automatically when the bath temperature drops to a safe value or must be manually reset by the operator.

The parameter is indicated by,

`Ct o r St` *Cutout reset mode parameter*

Press “SET” to access the parameter setting. Normally the cutout is set for manual mode.

`Ct o = r St` *Cutout set for manual reset*

To change to automatic reset mode press “UP” and then “SET”.

`Ct o = A u t o` *Cutout set for automatic reset*

9.12 Serial Interface Parameters

The serial RS-232 interface parameters menu is indicated by,

`S E R I A L` *Serial RS-232 interface parameters menu*

The serial interface parameters menu contains parameters which determine the operation of the serial interface. These controls only apply to baths fitted with the serial interface. The parameters in the menu are — BAUD rate, sample period, duplex mode, and linefeed.

9.12.1 Baud Rate

The baud rate is the first parameter in the menu. The baud rate setting determines the serial communications transmission rate.

The baud rate parameter is indicated by,

`B A U D` *Serial BAUD rate parameter*

Press “SET” to choose to set the baud rate. The current baud rate value will then be displayed.

`1200 b` *Current baud rate*

The baud rate of the bath serial communications may be programmed to 300,600,1200, or 2400 BAUD. Use “UP” or “DOWN” to change the baud rate value.

`2400 b` *New baud rate*

Press “SET” to set the baud rate to the new value or “EXIT” to abort the operation and skip to the next parameter in the menu.

9.12.2 Sample Period

The sample period is the next parameter in the serial interface parameter menu. The sample period is the time period in seconds between temperature measurements transmitted from the serial interface. If the sample rate is set to 5, the bath transmits the current measurement over the serial interface approximately every five seconds. The automatic sampling is disabled with a sample period of 0. The sample period is indicated by,

`SAMPLE` *Serial sample period parameter*

Press “SET” to choose to set the sample period. The current sample period value is displayed.

`SR= 1` *Current sample period (seconds)*

Adjust the value with “UP” or “DOWN” and then use “SET” to set the sample rate to the displayed value.

`SR= 50` *New sample period*

9.12.3 Duplex Mode

The next parameter is the duplex mode. The duplex mode may be set to full duplex or half duplex. With full duplex any commands received by the bath via the serial interface are immediately echoed or transmitted back to the device of origin. With half duplex the commands are executed but not echoed. The duplex mode parameter is indicated by,

`dUPL` *Serial duplex mode parameter*

Press “SET” to access the mode setting.

`dUP=FULL` *Current duplex mode setting*

The mode may be changed using “UP” or “DOWN” and pressing “SET”.

`dUP=HALF` *New duplex mode setting*

9.12.4 Linefeed

The final parameter in the serial interface menu is the linefeed mode. This parameter enables (on) or disables (off) transmission of a linefeed character (LF, ASCII 10) after transmission of any carriage-return. The linefeed parameter is indicated by,

LF *Serial linefeed parameter*

Press “SET” to access the linefeed parameter.

LF = 0 n *Current linefeed setting*

The mode may be changed using “UP” or “DOWN” and pressing “SET”.

LF = OFF *New linefeed setting*

9.13 IEEE-488 Parameters

Baths may optionally be fitted with an IEEE-488 GPIB interface. In this case the user may set the interface address within the IEEE-488 parameter menu. This menu does not appear on baths not fitted with the interface. The menu is indicated by,

IEEE *IEEE-488 parameters menu*

Press “SET” to enter the menu.

9.13.1 IEEE-488 Address

The IEEE-488 interface must be configured to use the same address as the external communicating device. The address is indicated by,

Address *IEEE-488 interface address*

Press “SET” to access the address setting.

Add = 22 *Current IEEE-488 interface address*

Adjust the value with “UP” or “DOWN” and then use “SET” to set the address to the displayed value.

Add = 15 *New IEEE-488 interface address*

9.14 Calibration Parameters

The operator of the bath controller has access to a number of the bath calibration constants namely CTO, CO, CG, H, and L. These values are set at the factory and must not be altered. The correct values are important to the accuracy and proper and safe operation of the bath. Access to these parameters is available to the user only so that in the event that the controller's memory fails the user may restore these values to the factory settings. The user should have a list of these constants and their settings with the manual.



CAUTION: DO NOT change the values of the bath calibration constants from the factory set values. The correct setting of these parameters is important to the safety and proper operation of the bath.

The calibration parameters menu is indicated by,



Calibration parameters menu

Press "SET" five times to enter the menu.

9.14.1 CTO

Parameter CTO sets the limit of the over-temperature cutout. This is not adjustable by software but is adjusted with an internal potentiometer. For the 6020 bath series this parameter should read as follows.

	6020	6021	6022	6024
CTO	310°C	210°C	310°C	310°C

9.14.2 CO and CG

These parameters calibrate the accuracy of the bath set-point. These are programmed at the factory when the bath is calibrated. Do not alter the value of these parameters. If the user desires to calibrate the bath for improved accuracy then calibrate R0 and ALPHA according to the procedure given in Section 11.

9.14.3 H and L

These parameters set the upper and lower set-point limits of the bath. DO NOT change the values of these parameters from the factory set values. To do so may present danger of the bath overheating and causing damage or fire.

10 Digital Communication Interface

If supplied with the option, the bath is capable of communicating with and being controlled by other equipment through the digital interface. Two types of digital interface are available — the RS-232 serial interface and the IEEE-488 GPIB interface.

With a digital interface the bath may be connected to a computer or other equipment. This allows the user to set the bath temperature, monitor the temperature, and access any of the other controller functions, all using remote communications equipment. In addition the heater power may be switched from low to high using the interface. To enable the heater to be switched to high using the interface the “HEATER” switch must be set to the “LOW” position.

10.1 Serial Communications

The bath may be installed with an RS-232 serial interface that allows serial digital communications over fairly long distances. With the serial interface the user may access any of the functions, parameters and settings discussed in Section 9 with the exception of the BAUD rate setting. The serial interface uses 8 data bits, 1 stop bit, and no parity.

10.1.1 Wiring

The serial communications cable attaches to the bath through the DB-9 connector at the back of the instrument. Figure 9 shows the pin-out of this connector and suggested cable wiring. To eliminate noise, the serial cable should be shielded with low resistance between the connector (DB-9) and the shield.

10.1.2 Setup

Before operation the serial interface of the bath must first be set up by programming the baud rate and other configuration parameters. These parameters are programmed within the serial interface menu.

To enter the serial parameter programming mode first press "EXIT" while pressing "SET" and release to enter the secondary menu. Press "SET" repeatedly until the display reads "PrObE". This is the menu selection. Press "UP" repeatedly until the serial interface menu is indicated with "SErIAL". Finally press "SET" to enter the serial parameter menu. In the serial interface parameters menu are the BAUD rate, the sample rate, the duplex mode, and the linefeed parameter.

10.1.2.1 Baud Rate

The baud rate is the first parameter in the menu. The display prompts with the baud rate parameter by showing "BAUD". Press "SET" to choose to set the baud rate. The current baud rate value is displayed. The baud rate of the bath serial communications may be programmed to 300,600,1200, or 2400 baud. The baud rate is pre-programmed to 1200 baud. Use "UP" or "DOWN" to change the baud rate value. Press "SET" to set the baud rate to the new value or "EXIT" to abort the operation and skip to the next parameter in the menu.

10.1.2.2 Sample Period

The sample period is the next parameter in the menu and prompted with "SRP-

RS-232 Cable Wiring for IBM PC and Compatibles

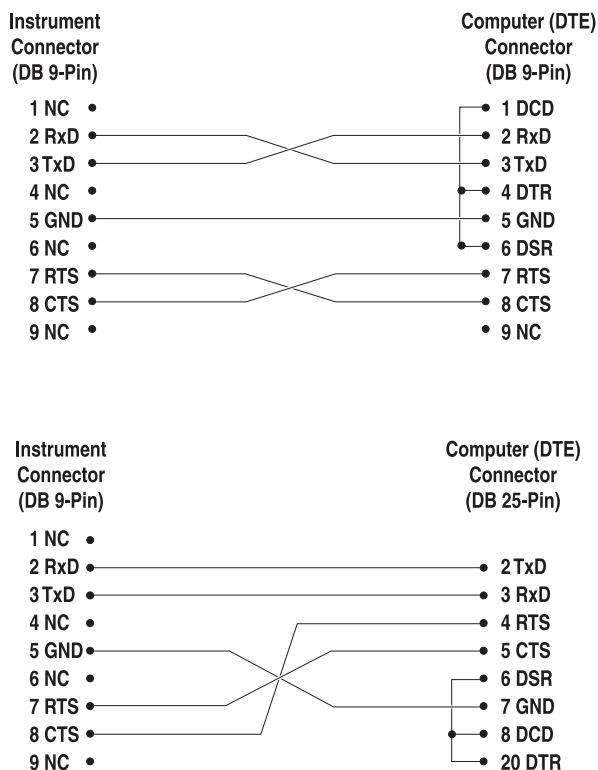

Figure 9 Serial Communications Cable Wiring

`PLE`". The sample period is the time period in seconds between temperature measurements transmitted from the serial interface. If the sample rate is set to 5, the bath transmits the current measurement over the serial interface approximately every five seconds. The automatic sampling is disabled with a sample period of 0. Press "SET" to choose to set the sample period. Adjust the period with "UP" or "DOWN" and then use "SET" to set the sample rate to the displayed value.

10.1.2.3 Duplex Mode

The next parameter is the duplex mode indicated with `DUPLEX`. The duplex mode may be set to half duplex (`HALF`) or full duplex (`FULL`). With full duplex any commands received by the thermometer via the serial interface are immediately echoed or transmitted back to the device of origin. With half duplex the commands are executed but not echoed. The default setting is full duplex. The mode may be changed using "UP" or "DOWN" and pressing "SET".

10.1.2.4 Linefeed

The final parameter in the serial interface menu is the linefeed mode. This parameter enables (`ON`) or disables (`OFF`) transmission of a linefeed character (LF, ASCII 10) after transmission of any carriage-return. The default setting is with linefeed on. The mode may be changed using "UP" or "DOWN" and pressing "SET".

10.1.3 Serial Operation

Once the cable has been attached and the interface set up properly the controller immediately begins transmitting temperature readings at the programmed rate. The set-point and other commands may be sent to the bath via the serial interface to set the bath and view or program the various parameters. The interface commands are discussed in [Section 10.3](#). All commands are ASCII character strings terminated with a carriage-return character (CR, ASCII 13).

10.2 IEEE-488 Communication (optional)

The IEEE-488 interface is available as an option. Baths supplied with this option may be connected to a GPIB type communication bus which allows many instruments to be connected and controlled simultaneously. To eliminate noise, the GPIB cable should be shielded.

10.2.1 Setup and Address Selection

To use the IEEE-488 interface first connect an IEEE-488 standard cable to the back of the bath.

Next set the device address. This parameter is programmed within the IEEE-488 interface menu.

To enter the IEEE-488 parameter programming menu first press "EXIT" while

pressing “SET” and release to enter the secondary menu. Press “SET” repeatedly until the display reaches “P r O b E”. This is the menu selection. Press “UP” repeatedly until the IEEE-488 interface menu is indicated with “I E E E”. Press “SET” to enter the IEEE-488 parameter menu. The IEEE-488 menu contains the IEEE-488 address parameter.

The IEEE-488 address is prompted with “A d d r E S S”. Press “SET” to program the address. The default address is 22. Change the device address of the bath if necessary to match the address used by the communication equipment by pressing “UP” or “DOWN” and then “SET”.

10.2.2 IEEE-488 Operation

Commands may now be sent via the IEEE-488 interface to read or set the temperature or access other controller functions. All commands are ASCII character strings and are terminated with a carriage-return (CR, ASCII 13). Interface commands are listed below.

10.3 Interface Commands

The various commands for accessing the bath controller functions via the digital interfaces are listed in this section (see Table 5). These commands are used with both the RS-232 serial interface and the IEEE-488 GPIB interface. In either case the commands are terminated with a carriage-return character. The interface makes no distinction between upper and lower case letters, hence either may be used. Commands may be abbreviated to the minimum number of letters which determines a unique command. A command may be used to either set a parameter or display a parameter depending on whether or not a value is sent with the command following a “=” character. For example “s”<CR> returns the current set-point and “s=50.00”<CR> sets the set-point to 50.00 degrees.

In the following list of commands, characters or data within brackets, “[” and “]”, are optional for the command. A slash, “/”, denotes alternate characters or data. Numeric data, denoted by “n”, may be entered in decimal or exponential notation. Characters are shown in lower case although upper case may be used. Spaces may be added within command strings and will simply be ignored. Backspace (BS, ASCII 8) may be used to erase the previous character. A terminating CR is implied with all commands.

10.4 Power Control Functions

The digital interface is capable of controlling the heating functions so that the bath can be remotely operated at any temperature within the range of the bath. To allow the interface to control the heating, the front panel controls are disabled by switching the heater switch to “LOW”. Otherwise, the interface can not switch the heater functions off. The 6020 series baths have one control function with the digital interface. This control function is for the heater settings.

To control the heater with the digital interface, the front panel heater switch must be set to “LOW”. The heater function is controlled with the “F1” command. This command is either set to “0” or “1” according to Table 4. The default setting is “F1=0” which is “LOW”. Sending a command without a parameter returns the state, “1” for on or “0” for off.

Table 4 Power Control Functions

Power	F1
LOW	0
HIGH	1

Table 5 Interface Command Summary

Command Description	Command Format	Command Example	Returned	Returned Example	Acceptable Values
Display Temperature					
Read current set-point	s[etpoint]	s	set: 9999.99 {C or F}	set: 150.00 C	
Set current set-point to <i>n</i>	s[etpoint]= <i>n</i>	s=450			Instrument Range
Read vernier	v[ernier]	v	v: 9.99999	v: 0.00000	
Set vernier to <i>n</i>	v[ernier]= <i>n</i>	v=.00001			Depends on Configuration
Read temperature	t[emperature]	t	t: 9999.99 {C or F}	t: 55.69 C	
Read temperature units	u[nits]	u	u: x	u: c	
Set temperature units:	u[nits]=c/f				C or F
Set temperature units to Celsius	u[nits]=c	u=c			
Set temperature units to Fahrenheit	u[nits]=f	u=f			
Secondary Menu					
Read proportional band setting	pr[op-band]	pr	pb: 999.9	pb: 15.9	
Set proportional band to <i>n</i>	pr[op-band]= <i>n</i>	pr=8.83			Depends on Configuration
Read cutout setting	c[utout]	c	c: 9999 {x},{xxx}	c: 620 C, in	
Set cutout setting:	c[utout]=<i>n</i>/r[eset]				
Set cutout to <i>n</i> degrees	c[utout]= <i>n</i>	c=500			Temperature Range
Reset cutout now	c[utout]=r[eset]	c=r			
Read heater power (duty cycle)	po[wer]	po	po: 9999	po: 1	
Configuration Menu					
Probe Menu					
Read R0 calibration parameter	r[0]	r	r0: 999.999	r0: 100.578	
Set R0 calibration parameter to <i>n</i>	r[0]= <i>n</i>	r=100.324			98.0 to 104.9
Read ALPHA calibration parameter	al[pha]	al	al: 9.9999999	al: 0.0038573	
Set ALPHA calibration parameter to <i>n</i>	al[pha]= <i>n</i>	al=0.0038433			.00370 to .00399
Operating Parameters Menu					
Read cutout mode	cm[ode]	cm	m: {xxxx}	m: AUTO	
Set cutout mode:	cm[ode]=r[eset]/a[uto]				RESET or AUTO
Set cutout to be reset manually-	cm[ode]=r[eset]	cm=r			

Interface Command Summary continued

Command Description	Command Format	Command Example	Returned	Returned Example	Acceptable Values
Set cutout to be reset automatically	cm[ode]=a[uto]	cm=a			
Serial Interface Menu					
Read serial sample setting	sa[mple]	sa	sa: 9	sa: 1	
Set serial sampling setting to <i>n</i> seconds	sa[mple]=n	sa=0			0 to 4000
Set serial duplex mode:	du[plex]=f[ull]/h[alf]				FULL or HALF
Set serial duplex mode to full	du[plex]=f[ull]	du=f			
Set serial duplex mode to half	du[plex]=h[alf]	du=h			
Set serial linefeed mode:	lf[eed]=on/of[f]				ON or OFF
Set serial linefeed mode to on	lf[eed]=on	lf=on			
Set serial linefeed mode to off	lf[eed]=of[f]	lf=of			
Calibration Menu					
Read C0 calibration parameter	*c0	*c0	b0: 9	b0: 0	
Set C0 calibration parameter to <i>n</i>	*c0=n	*c0=0			-999.9 to 999.9
Read CG calibration parameter	*cg	*cg	bg: 999.99	bg: 156.25	
Set CG calibration parameter to <i>n</i>	*cg=n	*cg=156.25			-999.9 to 999.9
Read low set-point limit value	*tl[ow]	*tl	tl: 999	tl: -80	
Set low set-point limit to <i>n</i>	*tl[ow]=n	*tl=-80			-999.9 to 999.9
Read high set-point limit value	*th[igh]	*th	th: 999	th: 205	
Set high set-point limit to <i>n</i>	*th[igh]=n	*th=205			-999.9 to 999.9
Miscellaneous (not on menus)					
Read firmware version number	*ver[sion]	*ver	ver.9999,9.99	ver.2100,3.56	
Read structure of all commands	h[elp]	h	list of commands		
Read Heater	f1	f1	f1:9	f1:1	
Set Heater	f1=1/0 (1=high, 0=low)				0 or 1
Set heater to low	f1= <i>n</i>	f1=0			
Set heater to high	f1= <i>n</i>	f1=1			
Legend:	<p>[] Optional Command data {} Returns either information n Numeric data supplied by user 9 Numeric data returned to user x Character data returned to user</p>				
Note:	When DUPLEX is set to FULL and a command is sent to READ, the command is returned followed by a carriage return and linefeed. Then the value is returned as indicated in the RETURNED column.				

11 Calibration Procedure

In some instances the user may want to calibrate the bath to improve the temperature set-point accuracy. Calibration is done by adjusting the controller probe calibration constants R0 and ALPHA so that the temperature of the bath as measured with a standard thermometer agrees more closely with the bath set-point. The thermometer used must be able to measure the bath fluid temperature with higher accuracy than the desired accuracy of the bath. By using a good thermometer and carefully following procedure the bath can be calibrated to an accuracy of better than 0.02°C over a range of 100 degrees.

11.1 Calibration Points

In calibrating the bath R0 and ALPHA are adjusted to minimize the set-point error at each of two different bath temperatures. Any two reasonably separated bath temperatures may be used for the calibration however best results will be obtained when using bath temperatures which are just within the most useful operating range of the bath. The farther apart the calibration temperatures the larger will be the calibrated temperature range but the calibration error will also be greater over the range. If for instance 50°C and 150°C are chosen as the calibration temperatures then the bath may achieve an accuracy of say $\pm 0.03^{\circ}\text{C}$ over the range 40 to 160°C . Choosing 80°C and 120°C may allow the bath to have a better accuracy of maybe $\pm 0.01^{\circ}\text{C}$ over the range 75 to 125°C but outside that range the accuracy may be only $\pm 0.05^{\circ}\text{C}$.

11.2 Measuring the Set-point Error

The first step in the calibration procedure is to measure the temperature errors (including sign) at the two calibration temperatures. First set the bath to the lower set-point, t_L . Wait for the bath to reach the set-point and allow 15 minutes to stabilize at that temperature. Check the bath stability with the thermometer. When both the bath and the thermometer have stabilized, measure the bath temperature with the thermometer and compute the temperature error err_L which is the actual bath temperature minus the set-point temperature. For example, if the bath is set for a lower set-point of $t_L=50^{\circ}\text{C}$ and the bath reaches a measured temperature of 49.7°C then the error is -0.3°C .

Next, set the bath for the upper set-point, t_H , and after stabilizing measure the bath temperature and compute the error, err_H . For our example, suppose the bath was set for 150°C and the thermometer measured 150.1°C giving an error of $+0.1^{\circ}\text{C}$.

11.3 Computing R0 and ALPHA

Before computing the new values for R0 and ALPHA the current values must be known. The values may be found by either accessing the probe calibration menu from the controller panel or by inquiring through the digital interface.

The user should keep a record of these values in case they may need to be re-stored in the future. The new values R_0' and $ALPHA'$ are computed by entering the old values for R_0 and $ALPHA$, the calibration temperature set-points t_L and t_H , and the temperature errors err_L and err_H into the following equations,

$$R_0' = \left[\frac{err_H t_L - err_L t_H}{t_H - t_L} ALPHA + 1 \right] R_0$$

$$ALPHA' = \left[\frac{(1 + ALPHA t_H)err_L - (1 + ALPHA t_L)err_H}{t_H - t_L} + 1 \right] ALPHA$$

For example, if R_0 and $ALPHA$ were previously set for 100.000 and 0.0038500 respectively and the data for t_L , t_H , err_L , and err_H were as given above then the new values R_0' and $ALPHA'$ would be computed as 100.193 and 0.0038272 respectively. Program the new values R_0 and $ALPHA$ into the controller. Check the calibration by setting the temperature to t_L and t_H and measuring the errors again. If desired the calibration procedure may be repeated again to further improve the accuracy.

11.4 Calibration Example

The bath is to be used between 75 and 125°C and it is desired to calibrate the bath as accurately as possible for operation within this range. The current values for R_0 and $ALPHA$ are 100.000 and 0.0038500 respectively. The calibration points are chosen to be 80.00 and 120.00°C. The measured bath temperatures are 79.843 and 119.914°C respectively. Refer to Figure 10 for applying equations to the example data and computing the new probe constants.

$$R_0 = 100.000$$

$$\text{ALPHA} = 0.0038500$$

$$t_L = 80.00^\circ\text{C}$$

$$\text{measured } t = 79.843^\circ\text{C}$$

$$t_H = 120.00^\circ\text{C}$$

$$\text{measured } t = 119.914^\circ\text{C}$$

Compute errors,

$$\text{err}_L = 79.843 - 80.00^\circ\text{C} = -0.157^\circ\text{C}$$

$$\text{err}_H = 119.914 - 120.00^\circ\text{C} = -0.086^\circ\text{C}$$

Compute R0,

$$R_0' = \left[\frac{(-0.086) \times 80.0 - (-0.157) \times 120.0}{120.0 - 80.0} \times 0.00385 + 1 \right] 100.000 = 100.115$$

Compute ALPHA,

$$\text{ALPHA}' = \left[\frac{(1 + 0.00385 \times 120.0)(-0.157) - (1 + 0.00385 \times 80.0)(-0.086)}{120.0 - 80.0} + 1 \right] 0.00385 = 0.0038387$$

Figure 10 Calibration Example

12 Maintenance

The calibration instrument has been designed with the utmost care. Ease of operation and simplicity of maintenance have been a central theme in the product development. Therefore, with proper care the instrument should require very little maintenance. Avoid operating the instrument in dirty or dusty environments.

- A battery is used to maintain operating parameters in the unit. All operating parameters, including calibration parameters should be checked on a regular basis to insure accuracy and proper operation of the instrument. See the troubleshooting section for the procedure on checking the status of the battery.
- The bath should be cleaned regularly to prevent a buildup of oil or dust. Use a paint safe cleaning agent on all painted surfaces. Solvents such as Trichloroethylene or Acetone may dull or dissolve the paint. The stainless steel surfaces may be cleaned with solvents as necessary to remove oils.
- The stirring motor should be clean to allow proper stirring. Normally only the outside surfaces require any attention. If the inside of the motor has become heavily loaded with oily dust, blow it out with compressed air. Follow normal safety procedures when using pressurized gasses.
- Periodically check the fluid level in the bath to ensure that the level has not dropped. A drop in the fluid level affects the stability of the bath. Changes in fluid level are dependent upon several factors specific to the environment in which the equipment is used. A schedule cannot be outlined to meet each environmental setting. Therefore, the first year the bath should be checked weekly with notes kept as to changes in bath fluid. After the first year, the user can set up a maintenance schedule based on the data specific to the application.
- Heat transfer medium lifetime is dependent upon the type of medium and the environment. The fluid should be checked at least every two weeks for the first year and regularly thereafter. This fluid check provides a baseline for knowledge of bath operation with clean, usable fluid. Once some fluids have become compromised, the break down can occur rapidly. Particular attention should be paid to the viscosity of the fluid. A significant change in the viscosity can indicate that the fluid is contaminated, being used outside of its temperature limits, contains ice particles, or is close to a chemical breakdown. Once data has been gathered, a specific maintenance schedule can be outline for the instrument. Refer to the General Operation section (Section 8) for more information about the different types of fluids used in calibration baths.
- If a hazardous material is spilt on or inside the equipment, the user is responsible for taking the appropriate decontamination steps as outlined by the national safety council with respect to the material. MSDS sheets applicable to all fluids used in the baths should be kept in close proximity to the instrument.

- If the mains supply cord becomes damaged, replace it with a cord with the appropriate gauge wire for the current of the bath. If there are any questions, call an Authorized Service Center for more information.
- Before using any cleaning or decontamination method except those recommended by Hart, users should check with an Authorized Service Center to be sure that the proposed method will not damage the equipment.
- If the instrument is used in a manner not in accordance with the equipment design, the operation of the bath may be impaired or safety hazards may arise.
- The over-temperature cutout should be checked every 6 months to see that it is working properly. In order to check the user selected cutout, follow the controller directions (Section 8.2) for setting the cutout. Both the manual and the auto reset option of the cutout should be checked. Set the bath temperature higher than the cutout. Check to see if the display flashes cutout and the temperature is decreasing. Note: When checking the over-temperature cutout, be sure that the temperature limits of the bath fluid are not exceeded. Exceeding the temperature limits of the bath fluid could cause harm to the operator, lab, and instrument.
- The constant temperature bath depends upon the certain qualities of the fluid medium in order to maintain a uniform and stable temperature environment. Some oils change their characteristics or become dirty after a period of use. Always remove any foreign materials from the bath.
- Silicone oils as well as others may evaporate off their lighter components over a period of time leaving the very viscous components remaining. In addition, some decomposition occurs which may impair the temperature stability of the bath. When this happens, the fluid is generally very dark to black and viscous. Vegetable oils polymerize (turn plastic like) after they have been used for a time at high temperatures making them very difficult to remove. When the oil has become unusable it should be changed. The instructions for removing the oil is as follows.

12.1 Draining the Bath

The drain is located on the back of the bath. See Figure 5 on page 26. Locate the drain plug on the end of the drain tube. The following information is helpful when draining the bath. Always use a container capable of holding the entire load of fluid. Using an adequate size (about 8 gallons or 1 cubic foot), heat proof fluid container is extremely important. Use safety equipment as appropriate.

1. Water and low viscosity fluids - Drain at room temperature. Normal care must be taken for fluids that may have corrosive or damaging effects on the surrounding facility or equipment.
2. High viscosity oils - The fluid should be sufficiently low in viscosity to drain efficiently. Some oils such as 710 silicone oil may need to be heated to 80 C to be fluid enough to drain well. The viscosity affects

how rapidly it drains as well as how well it flows off of the walls. Heat proof containers and appropriate safety equipment such as face shields, gloves and body covering should be used.



WARNING: *Extreme danger of BURNS and FIRE. Use safety equipment. Use proper equipment, and have fire safety equipment standing by.*

13 Troubleshooting

13.1 Troubleshooting

In the event the bath appears to function abnormally this section may help to find and solve the problem. Several possible problem conditions are described along with likely causes and solutions. If a problem arises please read this section carefully and attempt to understand and solve the problem. If the bath seems faulty or the problem cannot otherwise be solved, then contact an Authorized Service Center (see Section 1.3) for assistance. Opening the unit without contacting an Authorized Service Center may void the warranty.

Problem	Causes and Solutions
The heater indicator LED stays red but the temperature does not increase	<p>If the display does not show “cutout” and shows the correct bath temperature, consider the following possibilities:</p> <p>Insufficient heating. Insufficient heating may be caused by the heater power setting being too low, especially at higher operating temperatures. Switching to the higher heater power switch setting, if available, may solve the problem.</p> <p>No heating. This is caused by blown heater fuses and/or burned out heaters. Always replace the fuse with one of the same rating, voltage, and type. Never replace the fuse with one of a higher current rating. Check the heater fuses to make sure that they are still good. Access the heater fuses by removing the back panel covering the display electronics. If they are blown, and continue to blow when replaced, the heaters may be shorted. If you suspect that the heaters are shorted or burned out, contact an Authorized Service Center (see Section 1.3) for assistance.</p>
The controller display flashes “Cutout” and the heater does not operate	<p>If the display flashes “Cutout” alternately with the correct process temperature, check the following:</p> <p>Wrong cutout setting. The cutout disconnects power to the heaters when the bath temperature exceeds the cutout set-point. This causes the bath temperature to drop back down to a safe value. If the cutout mode is set to “AUTO”, the heater switches back on when the temperature drops. If the mode is set to “RE-SET”, the heater only comes on again when the temperature is reduced and the cutout is manually reset by the operator. (Refer to section 9.2.)</p> <p>Check that the cutout set-point is adjusted to 10 or 20°C above the desired maximum bath operating temperature and that the cutout mode is set as desired.</p> <p>Bad cutout. If the cutout activates when the bath temperature is well below the cutout set-point or the cutout does not reset when the bath temperature drops and it is manually reset, the cutout circuitry may be faulty. Try performing the Factory Reset Sequence explained below.</p> <p>Factory Reset Sequence - Hold the “SET” and “EXIT” keys down at the same time while powering up the unit. The display shows “init”, the model number, and the firmware version. Each of the controller parameters and calibration constants must be re-programmed. The values can be found on the Report of Calibration that was shipped with the instrument.</p>

Problem	Causes and Solutions
The display flashes "Cutout" alternately with an incorrect process temperature	<p>Low battery. A problem could exist with the memory back-up battery. If the battery voltage is insufficient to maintain the memory, data may become scrambled causing problems. A nearby large static discharge may also affect data in memory. Access the battery by removing the back panel covering the display electronics.</p> <p>Corrupt controller memory. If the problem reoccurs after the battery is replaced, initialize the memory by performing a Factory Reset Sequence (described in a previous solution).</p>
The controller displays the wrong temperature and the bath continually heats or cools regardless of the set-point value	<p>Bad control probe. The bath control probe may be disconnected, burned out, or shorted. Check first that the probe is connected properly to the socket in the rear of the bath labeled "PROBE".</p> <p>The probe may be checked with an ohmmeter to see if it is open or shorted. The probe is a platinum 4-wire Din 43760 type. The resistance should read 0.2 to 2.0 ohms between pins 1 and 2 on the probe connector and 0.2 to 2.0 ohms between pins 3 and 4. The resistance should read from 100 to 300 ohms between pins 1 and 4 depending on its current temperature.</p> <p>Corrupt controller memory. Initialize the memory by performing a Factory Reset Sequence (described in a previous solution).</p>
The controller controls or attempts to control at an inaccurate temperature	<p>If the controller appears to operate normally except that the bath's temperature does not agree with the temperature measured by the user's reference thermometer to within the specified accuracy, consider the following:</p> <p>Erroneous parameters. Check that the calibration parameters are all correct according to the Report of Calibration. If not, reprogram the constants. If the controller does not keep the correct parameters, the memory backup battery may be weak causing errors in data. See "Low Battery" in a previous solution.</p> <p>Poor uniformity. There may be an actual difference between the bath's control probe and the reference thermometer due to excess gradients in the bath. Check that the bath has an adequate amount of fluid in the tank and that the stirrer is operating properly. Also check that the reference thermometer and control probe are both fully inserted into the bath to minimize temperature gradient errors.</p> <p>Bad control probe. Check that the control probe has not been struck, bent, or damaged. Refer to the previous solution for how to check the probe's resistance.</p>

Problem	Causes and Solutions
<p>The controller shows that it is controlling at the proper temperature, but the bath temperature is unstable</p>	<p>If the bath does not achieve the expected degree of temperature stability when measured using a thermometer, consider the following:</p> <p>Wrong proportional band setting. If the proportional band is set too narrow, the bath will oscillate causing poor stability. In this case, increase the width of the proportional band.</p> <p>If the proportional band setting is too wide, the long-term stability of the bath is affected. In this case decrease the width of the band. (Refer to Section 9.7.)</p> <p>Bath fluid is too thick. Make sure that the bath fluid used is less than 50 centi-Stokes (10 is ideal) at the temperature at which the bath is controlling. Check the fluid manufacturer's specifications.</p> <p>You should also change the bath fluid regularly and if it changes colors or becomes too thick.</p> <p>Bad control probe. Check that the control probe has not been struck, bent, or damaged. Refer to the previous solution for how to check the probe's resistance.</p>
<p>The controller alternately heats for a while then cools</p>	<p>Wrong proportional band setting. If the proportional band is set too narrow, the bath will oscillate between too much heating and too much cooling causing instability. Increase the width of the proportional band until the temperature stabilizes. (Refer to section 9.7.)</p>
<p>The controller does not maintain controller parameters or parameters are reset each time the power to the unit is removed</p>	<p>Note: Before performing the memory check, you need to record the controller calibration parameters (found in the CAL menu of the instrument) and any user-adjusted parameters that you have changed (such as the programmable set points and proportional band).</p> <p>Memory Check</p> <p>Doing a memory check is the easiest way to verify the ability of the battery to maintain controller parameters.</p> <ol style="list-style-type: none"> 1. Power off the instrument. 2. Disconnect the instrument from AC power for 10 seconds. 3. Reconnect the AC power and power on the instrument. 4. If the display shows "InIT" and/or the cycle count shows a low number such as 0002, the battery is spent and should be replaced. Contact an Authorized Service Center for assistance. 5. After replacing the battery, you must reprogram the calibration and user-adjustable parameters into the controller.
<p>Power Up</p>	<p>The instrument is equipped with operator accessible fuses. If a fuse blows, it may be due to a power surge or failure of a component. Replace the fuse once. Always replace the fuse with one of the same rating, voltage, and type. Never replace the fuse with one of a higher current rating. If the fuse blows a second time, it is likely caused by failure of a component part. If this occurs, contact an Authorized Hart Scientific Service Center.</p>

14 Appendix – Model 6021

The Hart Scientific 6021 is a heated bath adapted for use with a chiller. A switch on the back of the controller permits the use of the chiller in an automated or manual mode.

14.1 Installation

The information contained here is in addition to that in the Section 5 (Installation) of this manual.

The bath and chiller must be level and operating in an appropriate environment prior to installation. Refer to the chiller manual for details on chiller installation, filling and operation. The general installation of a chiller is as follows.

1. Connect the tubing lines between the chiller and the bath. Quick-disconnect fittings, if installed on chiller, make attaching tubing lines easy. Be sure the lines fit securely on the chiller so they do not disconnect during operation. Either cooling tube on the 6021 bath may be used as inlet or outlet.

If the hoses are not connected to the 6021 bath already, connect them securely with hose clamps. Silicone rubber tubing is typically used, although resistant to high temperatures it is not compatible with silicone oils.

2. If applicable, fill the chiller with the appropriate fluid to between 1 and 1.5 inches below the lid. If unsure on how to fill the chiller, consult the chiller manual. Water works for most applications. After operating the chiller for a short period of time, check the fluid level in the chiller. More fluid may have to be added to the chiller, due to fluid required to fill the newly attached system. DO NOT use the chiller above it's maximum recommended temperature. Some chillers automatically cut out when the maximum operating temperature is exceeded (consult the chiller manual for more information).



WARNING: *Water left in the 6021 bath cooling coils will boil as the bath temperature increases above the boiling point. This process is slow and safe as long as the lines to the chiller are unobstructed. Otherwise, a dangerous health hazard may exist.*

3. Connect the power plug for the chiller to the Auxiliary Chiller Outlet on the rear of the 6021 controller. The bath also needs to be setup and powered on. Use the appropriate mains voltage with an adequate current capacity available. Refer to Section 3.1, Specifications and Environmental Conditions for all power requirements and specifications.

If the bath is in high heat mode or switched to high heat mode, the chiller output is automatically disabled. Therefore, high heat mode will override

the chiller operation, but the chiller mode cannot override the high heat mode. The chiller option can only be used when the bath is in low heat mode. The bath operates as such, since it is not capable of supplying the current required to run a chiller and high heat mode simultaneously. This functionality applies to both manual and automatic control as long as the chiller is powered by the 6021 bath.



WARNING: *Insure that the chiller fluid is compatible with the operating temperature of the 6021.*

4. Set the chiller temperature to at least 10°C below the bath temperature. To test the cooling system make sure the 6021 controller is on and then set the Auxiliary Chiller Outlet switch on the back of the 6021 bath to On (not Auto). When the chiller power switch is turned on, the chiller power indicator and in some cases the chilled water solenoid will energize. In the case of a chiller, the instrument will engage and begin to pump fluid. In the case of a chilled water system, the solenoid valve will open and begin to circulate fluid through the system. The 6021 temperature should begin to decrease and approach the new set-point, or the duty-cycle of the bath will increase as the 6021 attempts to maintain the current set-point.

14.2 Chiller Parts and Controls

The information contained here is for the chiller parts and controls and is in addition to that in the Section 7 (Parts and Controls) of this manual. The auxiliary chiller controls for the 6021 bath are located on the rear of the controller panel.

The controls are illustrated in Figure 11 and include: the On/Auto control switch, the auxiliary power outlet, and the cooling tube connections.

1. The On/Auto control switch allows the system to switch between manual and computer control. For manual power, move the switch to the On position. For computer control move the switch to the Auto position. A computer program may be written to permit control of all 6021 functions as well as turning the power off and on to the chiller from the 6021 auxiliary chiller outlet.
2. The Auxiliary Chiller Outlet power connector can supply the current listed in Section 3.1, Specifications. DO NOT connect a higher load.
3. The cooling tube connections permit the attachment of a chiller, compressed air, tap water, or other source cooling. The tubes are 3/8 inch outside diameter (OD) copper. These tubes connect to two cooling plates attached to the bottom and back walls of the bath. Use 3/8 inch inside diameter (ID) tubing to connect to the cooling source.



Figure 11 6021 Back panel

14.3 Chiller Controller Operation

Sections 8 (General Operation), 9 (Controller Operation), and 10 (Digital Communications) of this manual explain the general operation, controller operation, and digital communications for the 6021 bath. The digital interface is also capable of turning the auxiliary chiller on and off as shown in Table 6. The chiller must be connected as described in the Installation portion of this Appendix and the auxiliary switch must be turned to the Auto position. The bath heater position must be in low.

Table 6 Auxiliary Chiller Control Functions

Chiller State	F2
Off	0
On	1